

HNO-Instrumente
ENT-Instruments
Instruments ORL
Instrumental ORL

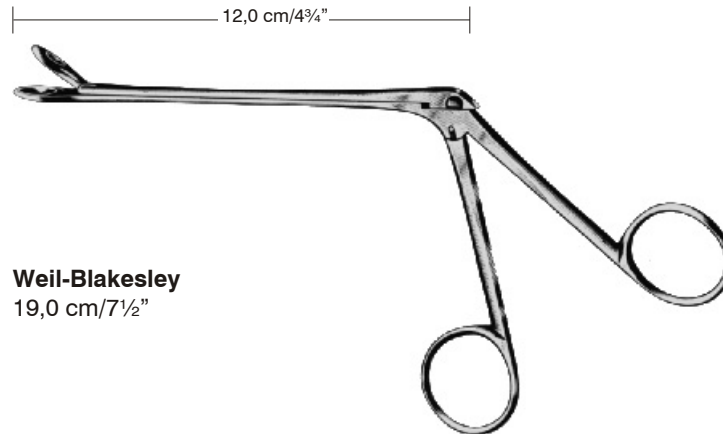

Scharfe Nasenzangen
Nasal Cutting Forceps
Pinces coupantes pour le nez
Pinzas cortantes para la nariz



Weil-Blakesley
 19,0 cm / 7 1/2"

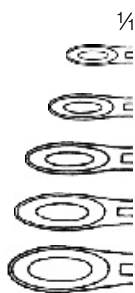

gerade straight droite recta	Standard	mit Absaugrohr with suction tube avec tube d'aspiration con tubo de aspiración
2,5 mm	HB 5401	HB 5421
3,6 mm	HB 5402	HB 5422
4,8 mm	HB 5403	HB 5423
5,3 mm	HB 5404	HB 5424
6,3 mm	HB 5405	HB 5425



45° aufgebogen 45° curved upwards 45° courbe en haut 45° curva arriba	Standard	mit Absaugrohr with suction tube avec tube d'aspiration con tubo de aspiración
2,5 mm	HB 5406	HB 5426
3,6 mm	HB 5407	HB 5427
4,8 mm	HB 5408	HB 5428
5,3 mm	HB 5409	HB 5429
6,3 mm	HB 5410	HB 5430

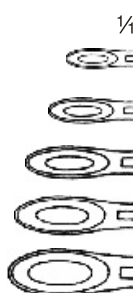

90° aufgebogen 90° curved upwards 90° courbe en haut 90° curva arriba	Standard	mit Absaugrohr with suction tube avec tube d'aspiration con tubo de aspiración
2,5 mm	HB 5411	HB 5431
3,6 mm	HB 5412	HB 5432
4,8 mm	HB 5413	HB 5433
5,3 mm	HB 5414	HB 5434
6,3 mm	HB 5415	HB 5435

Scharfe Nasenzangen
Nasal Cutting Forceps
Pincès coupantes pour le nez
Pinzas cortantes para la nariz

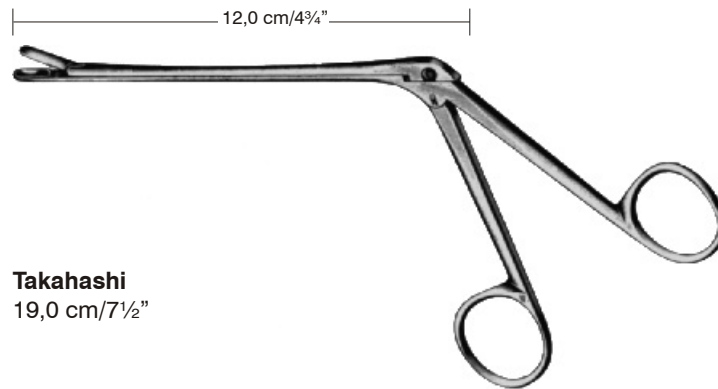

Takahashi
 19,0 cm / 7 1/2"



gerade straight droite recta		Standard	mit Absaugrohr with suction tube avec tube d'aspiration con tubo de aspiración
Fig. 1	2,5 mm	HB 5416	HB 5436
Fig. 2	4,0 mm	HB 5417	HB 5437



45° aufgebogen 45° curved upwards 45° courbe en haut 45° curva arriba		Standard	mit Absaugrohr with suction tube avec tube d'aspiration con tubo de aspiración
Fig. 1	2,5 mm	HB 5418	HB 5438
Fig. 2	4,0 mm	HB 5419	HB 5439

Nasenzangen (Doppellöffel)
Nasal Forceps (Biopsy Forceps)
Pinces pour le nez (Pinces emporte-pièce à biopsie)
Pinzas para la nariz (Pinzas para biopsia)

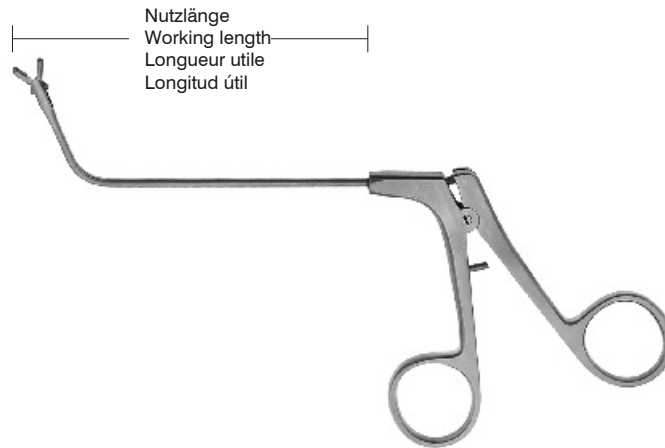

HB 5440
gerade
straight
droite
recta

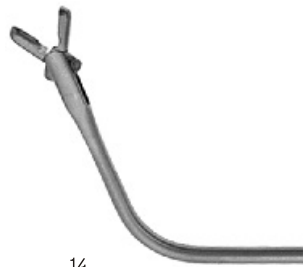

HB 5441
70° aufgebogen
70° curved upwards
70° courbe en haut
70° curva arriba



HB 5442
110° aufgebogen
110° curved upwards
110° courbe en haut
110° curva arriba

	Maul Jaw Mors Boca	Nutzlänge Working length Longueur utile Longitud útil
HB 5440	3 x 4,5 mm	110 mm
HB 5441	3 x 4,5 mm	80 mm
HB 5442	3 x 4,5 mm	70 mm

Nasenzangen (durchschneidend)
Punch Forceps (cutting)
Pinces coupantes pour le nez
Pinzas cortantes para la nariz

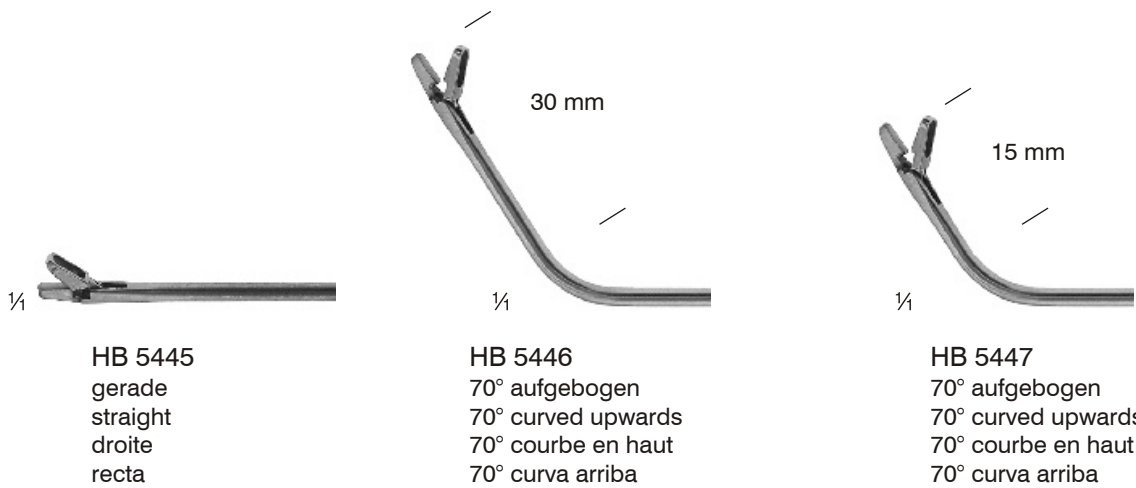
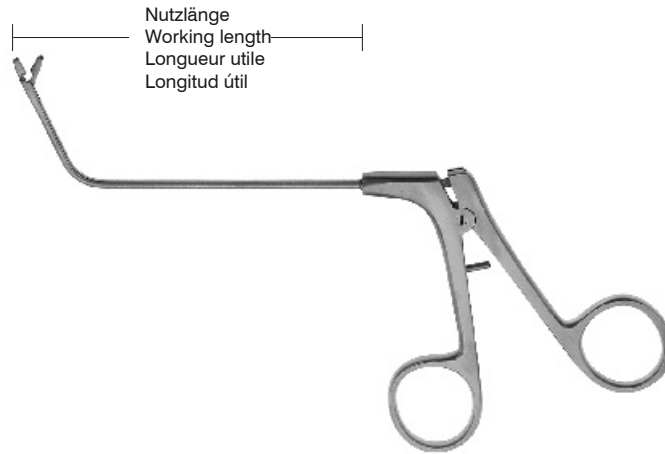

HB 5445
gerade
straight
droite
recta



HB 5446
70° aufgebogen
70° curved upwards
70° courbe en haut
70° curva arriba

HB 5447
70° aufgebogen
70° curved upwards
70° courbe en haut
70° curva arriba

	Maul Jaw Mors Boca	Nutzlänge Working length Longueur utile Longitud útil
HB 5445	1,5 x 5 mm	110 mm
HB 5446	1,5 x 5 mm	80 mm
HB 5447	1,5 x 5 mm	80 mm

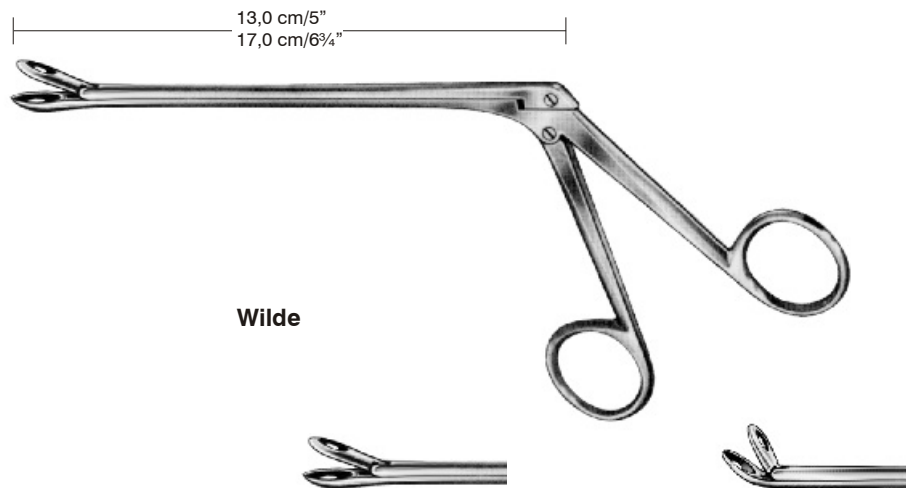
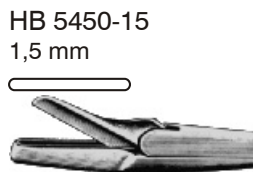
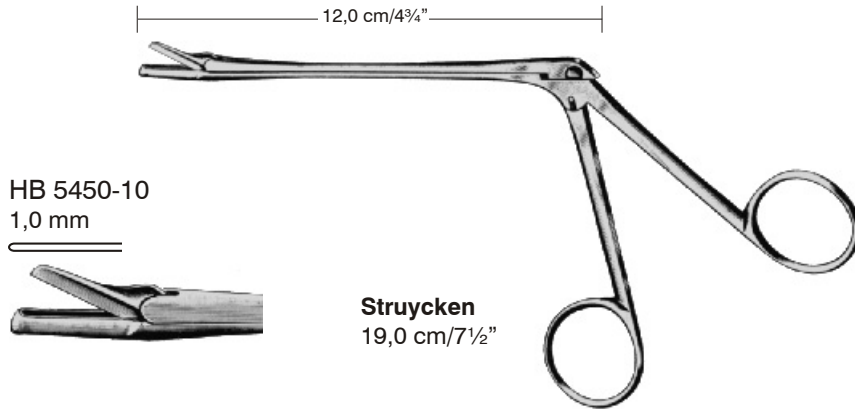
Scharfe Nasenzangen
Nasal Cutting Forceps
Pinces coupantes pour le nez
Pinzas cortantes para la nariz

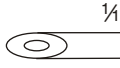

	Bißbreite Width of bite Grandeur de coupe Ancho de la boca	Schaftlänge, Length of shaft Longueur de tige, Largo del asta		Schaftlänge, Length of shaft Longueur de tige, Largo del asta	
		13,0 cm/5"	17,0 cm/6 3/4"	13,0 cm/5"	17,0 cm/6 3/4"
	3 x 8 mm	HB 5452-13	HB 5452-17	HB 5455-13	HB 5455-17
	4 x 10 mm	HB 5453-13	HB 5453-17	HB 5456-13	HB 5456-17
	5 x 12 mm	HB 5454-13	HB 5454-17	HB 5457-13	HB 5457-17

Nasenscheren
Nasal Scissors
Ciseaux pour le nez
Tijeras nasales

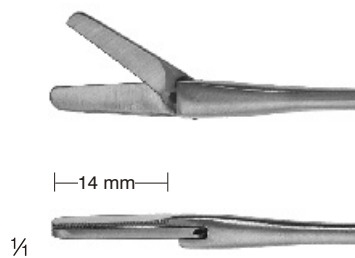
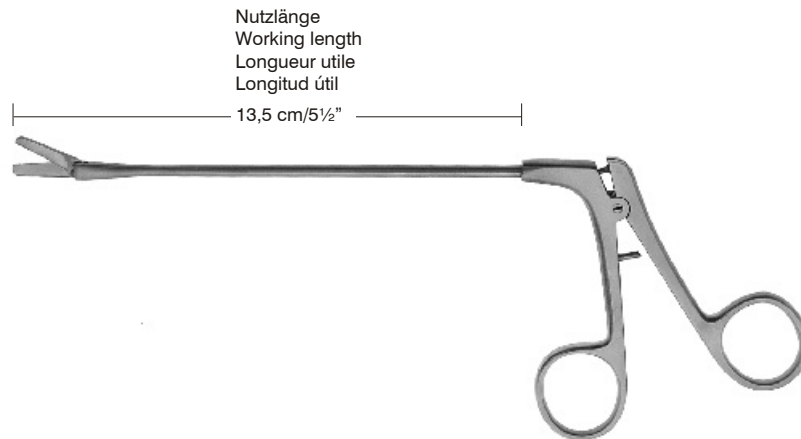

HB 5460
 gerade
 straight
 droite
 recta

1 Schneide gezahnt
 1 Blade toothed
 1 Tranchant dentelé
 1 Filo dentado

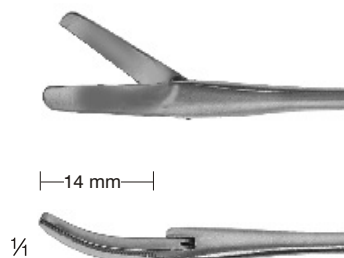

HB 5461
 nach rechts gebogen
 curved to the right
 courbe à droite
 curva hacia la derecha

1 Schneide gezahnt
 1 Blade toothed
 1 Tranchant dentelé
 1 Filo dentado

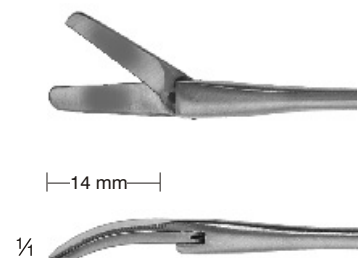

HB 5462
 nach links gebogen
 curved to the left
 courbe à gauche
 curva hacia la izquierda

1 Schneide gezahnt
 1 Blade toothed
 1 Tranchant dentelé
 1 Filo dentado

Septumscheren
Septum Scissors
Ciseaux pour la cloison nasale
Tijeras para el tabique nasal



gezahnt
toothed
dentelés
dentadas



Caplan

HB 5470
20,0 cm/8"

gezahnt
toothed
dentelés
dentadas



Killian

HB 5471
21,0 cm/8½"

Septumzangen
Septum Forceps
Pinces pour la cloison nasale
Pinzas para el tabique nasal



Rubin

HB 5472-01
21,0 cm/8½"

TC-Rubin

HB 5472-02
21,0 cm/8½"

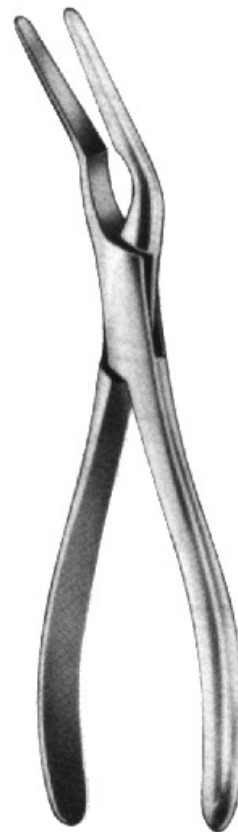

Asch

HB 5473
22,0 cm/8¾"



HB 5501

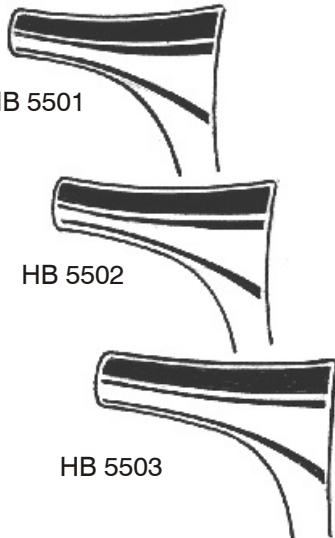

HB 5502

HB 5503

Hartmann
 16,5 cm/6½"



HB 5506

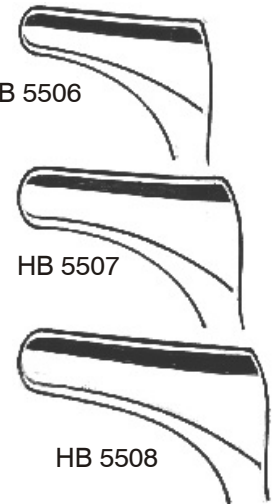

HB 5507

HB 5508

Hartmann-Halle
 15,0 cm/6"



Tieck-Halle

HB 5510
 13,5 cm/5¼"



Tieck-Halle

HB 5511
 13,5 cm/5¼"



Cottle
 16,5 cm/6½"

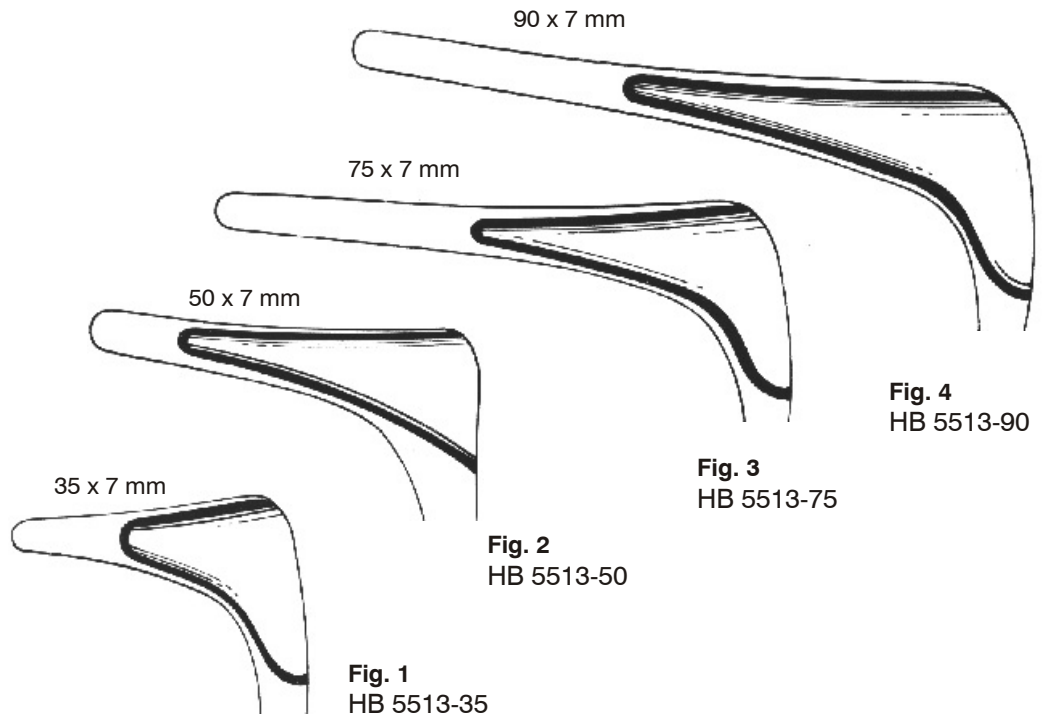

Fig. 1
 HB 5513-35

Fig. 2
 HB 5513-50

Fig. 3
 HB 5513-75

Fig. 4
 HB 5513-90



Cottle
 14,0 cm/5½"

Schwarz verchromt
 black chromium plated
 chromé en noir
 cromado en negro

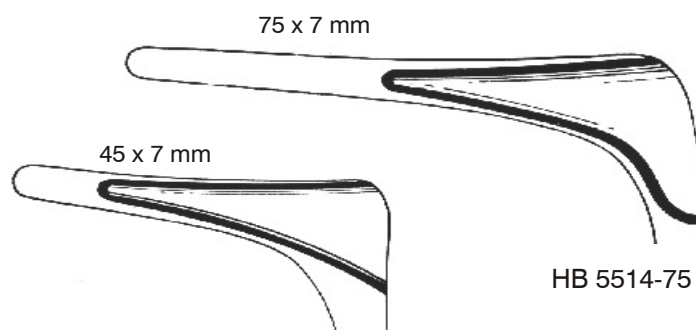

HB 5514-45

HB 5514-75



Killian
 13,0 cm/5"



HB 5515
 35 mm

HB 5516
 50 mm

HB 5517
 75 mm

HB 5518
 90 mm



Thudichum (Goldsmith)
 6,5 cm/2½"



Fig. 1
 HB 5522-01

Fig. 2
 HB 5522-02

Fig. 3
 HB 5522-03

Fig. 4
 HB 5522-04



Fig. 5
 HB 5522-05

Fig. 6
 HB 5522-06

Fig. 7
 HB 5522-07

Polypenschnürer
Nasal Polypus Snares
Serre-nœuds pour polypes
Polipótomos nasales



Krause

HB 5530
 26,0 cm/10¼"



Krause-Voss

HB 5531
 26,0 cm/10¼"

Stahldraht für Polypenschnürer
 Steel wire for nasal snares
 Anses en fil d'acier pour serre-nœuds
 Alambre de acero para polipótomos



HB 6018 0,3 mmØ
 Pack à 12 Stück
 Pack of 12 pieces
 Paquet à 12 pièces
 Paquete con 12 piezas



10 m / 33ft.
 HB 5532-30 0,3 mmØ
 HB 5532-40 0,4 mmØ

Polypenzangen
Nasal Polypus Forceps
Pinces à polypes nasaux
Pinzas para pólipos nasales



Hartmann

HB 5549 13,0 cm/5"
HB 5550 16,0 cm/6¼"

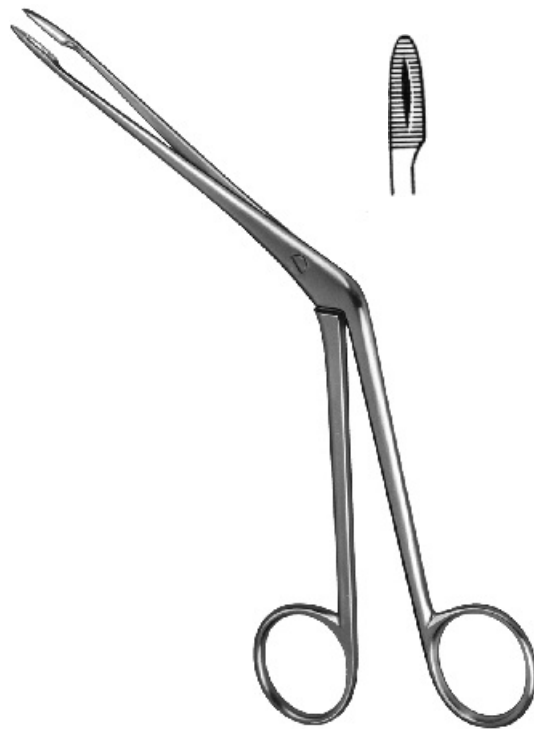

Hartmann

HB 5551 20,0 cm/8"



Heymann-Knight

HB 5552 18,0 cm/7"



Littauer

HB 5553 18,0 cm/7"

Nasen- und Ohrpinzetten
Nasal and Ear Dressing Forceps
Pinces nasales et auriculaires
Pinzas nasales y auriculares



Troeltsch (Wilde)

- HB 5554 11,0 cm/4½"
- HB 5555 12,0 cm/4¾"
- HB 5556 15,0 cm/6"
- HB 5557 18,0 cm/7"



Troeltsch (Wilde) 1 x 2

- HB 5559 12,0 cm/4¾"
- HB 5560 15,0 cm/6"



bajonettförmig
 bayonet-shaped
 en forme de baïonette
 en forma de bayoneta

Jansen

- HB 5562 16,0 cm/6½"
- HB 5563 18,0 cm/7"

Grünwald-Jansen

- HB 5564 20,0 cm/8"



Lucae

- HB 5565 14,0 cm/5½"



Lucae 1 x 2

- HB 5566 14,0 cm/5½"



Cottle

- HB 5567 14,0 cm/5½"

Nasenzangen
Nasal Forceps
Pinces pour le nez
Pinzas para la nariz



Westmacott

HB 5568 20,0 cm/8"



Graig

HB 5569 18,0 cm/7"

Nasen-Septumzange
 Nasal Septum Forceps
 Pinces pour la cloison nasale
 Pinzas para el tabique nasal

Septumzange
 Septum Forceps
 Pince pour la cloison nasale
 Pinza para el tabique nasal

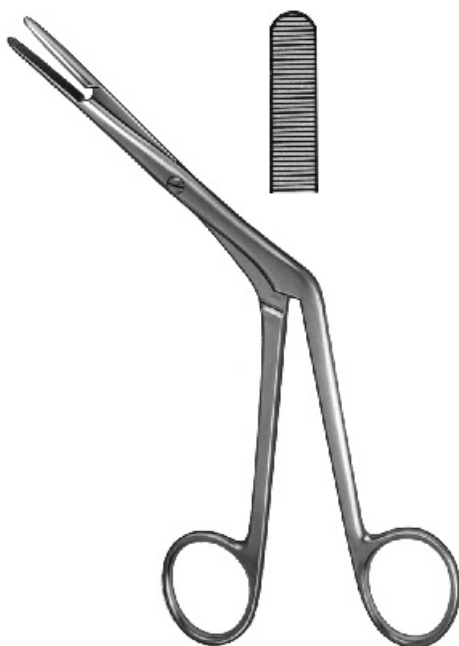

Killian

HB 5570 17,0 cm/6¾"



Knight

HB 5571-18 18,0 cm/7"



Luc

20,0 cm/8"



Fig. 1
 HB 5573-01

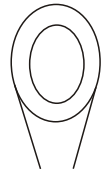

Fig. 2
 HB 5573-02

Siebbeinzange
 Ethmoid Forceps
 Pince ethmoïdales
 Pinza para etmoides

Septumzangen
Septum Forceps
Pinces pour la cloison nasale
Pinzas para el tabique nasal



durchschneidend
through-cutting
coupantes des deux côtés
bocas cortantes la una en la otra

Middleton-Jansen

HB 5574-01
19,0 cm/7½"



Löffelmaul
spoon-shaped jaw
mors en forme d'un cuiller
con boca en forma de cucharilla

Middleton-Jansen

HB 5574-02
19,0 cm/7½"

Keilbeinstanzen
Sphenoid Punches
Pinces emporte-pièces pour sinus sphénoïdal
Pinzas cortantes para seno esfenoidal

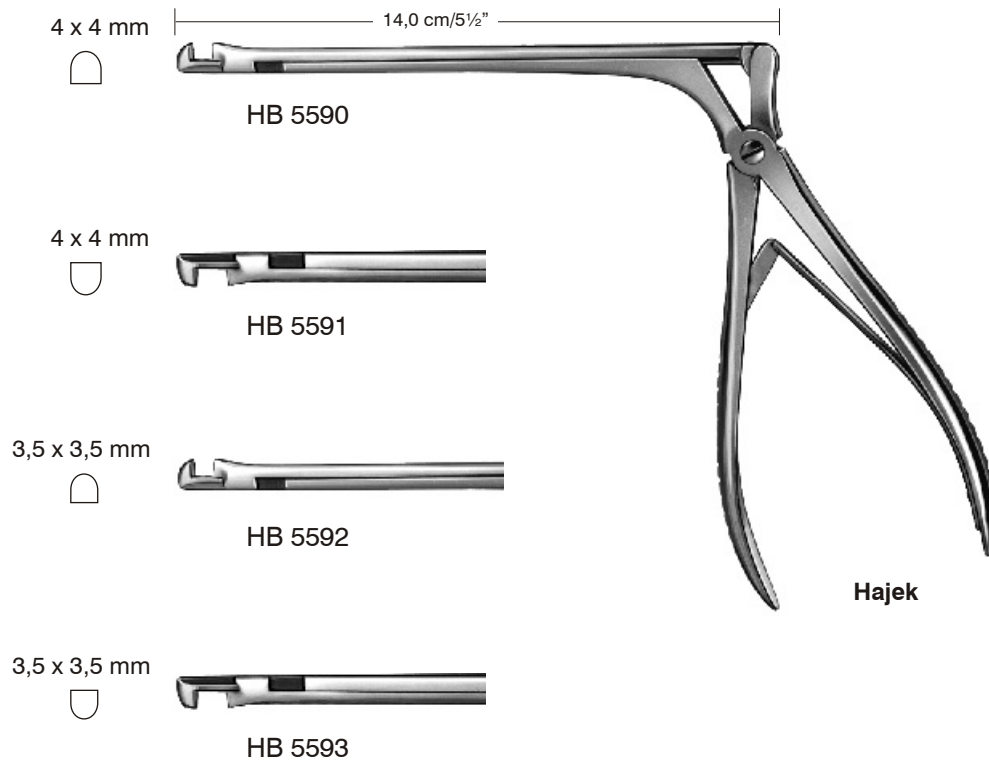

Kieferhöhlenstanze
Antrum Punch Forceps
Pinces emporte-pièces pour sinus maxillaire
Pinzas cortantes para seno maxilar

- 
HB 5596
 4 mm
- 
HB 5597
 5 mm
- 
HB 5598
 6 mm



Septum-Elevatorien
Septum Elevators
Élévateurs pour la cloison nasale
Elevadores para el tabique nasal

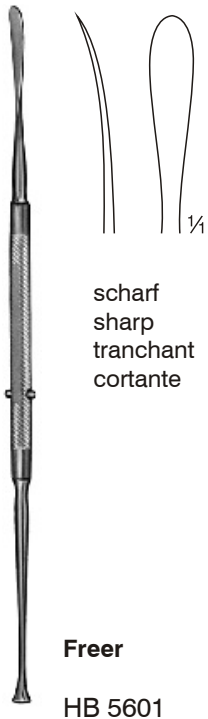

scharf
sharp
tranchant
cortante

Freer
HB 5601

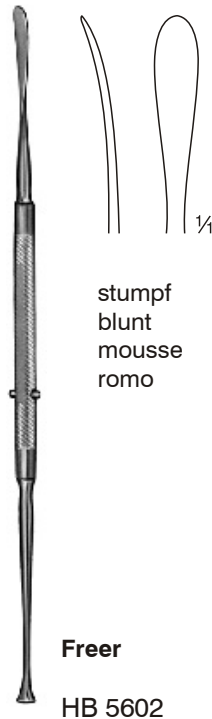

stumpf
blunt
mousse
romo

Freer
HB 5602

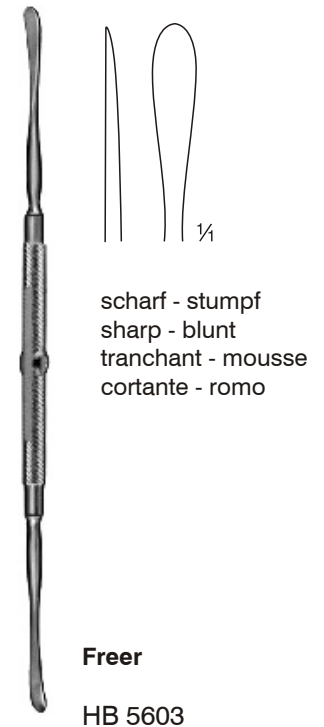

scharf - stumpf
sharp - blunt
tranchant - mousse
cortante - romo

Freer
HB 5603

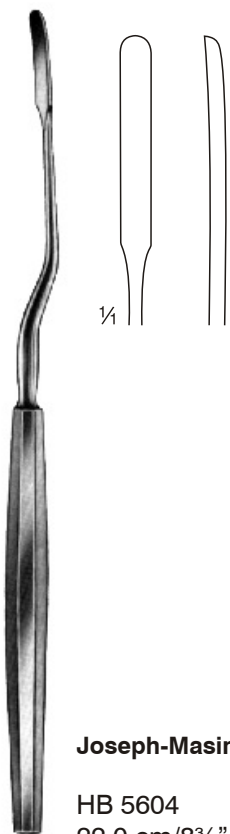

Joseph-Masing
HB 5604
22,0 cm/8³/₄"

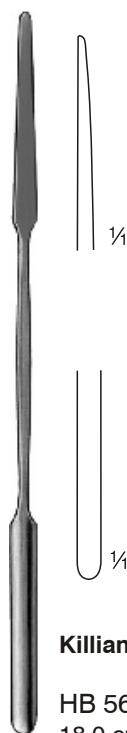

Killian
HB 5605
18,0 cm/7"

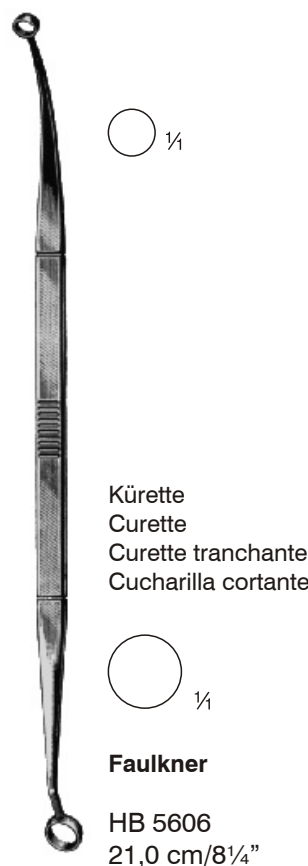

Kürette
Curette
Curette tranchante
Cucharilla cortante

Faulkner
HB 5606
21,0 cm/8¹/₄"

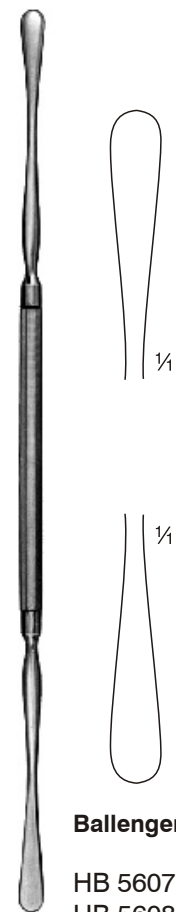

Ballenger-Hajek
HB 5607 19,0 cm/7¹/₂"
HB 5608 22,0 cm/8³/₄"

Septum- und Periost-Elevatoren
Septum and Periosteal Elevators
Élévateurs pour la cloison et le périoste
Elevadores para el tabique nasal y para el periostio

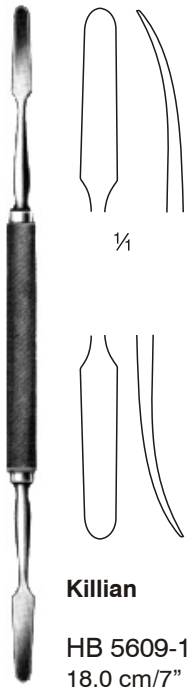

Killian

HB 5609-18
18,0 cm/7"

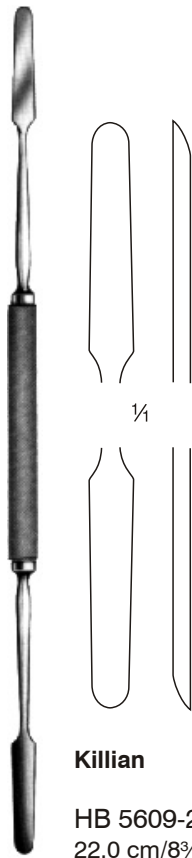

Killian

HB 5609-22
22,0 cm/8¾"

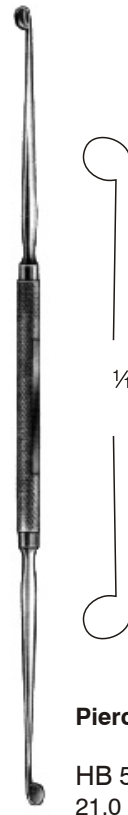

Pierce

HB 5610
21,0 cm/8½"

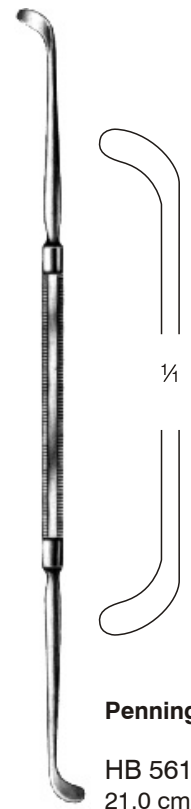

Pennington

HB 5611
21,0 cm/8½"

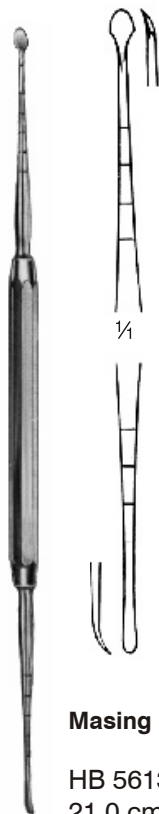

Masing

HB 5613
21,0 cm/8½"

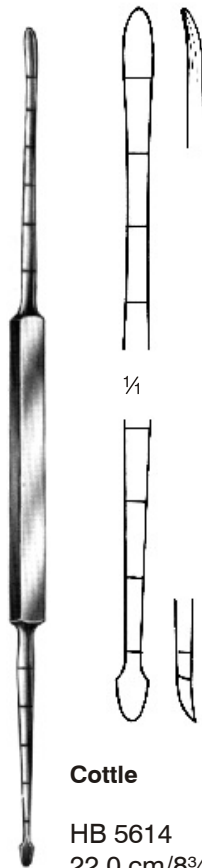

Cottle

HB 5614
22,0 cm/8¾"

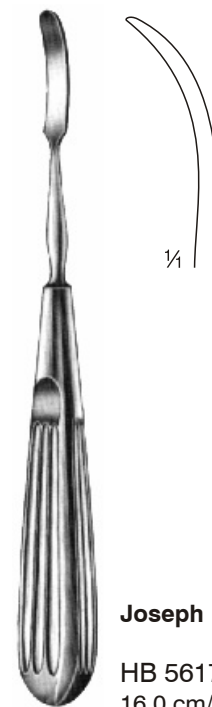

Joseph

HB 5617
16,0 cm/6¼"

Nasen-Osteotome
Nasal Osteotomes
Osteotomes nasales
Osteotomos nasales

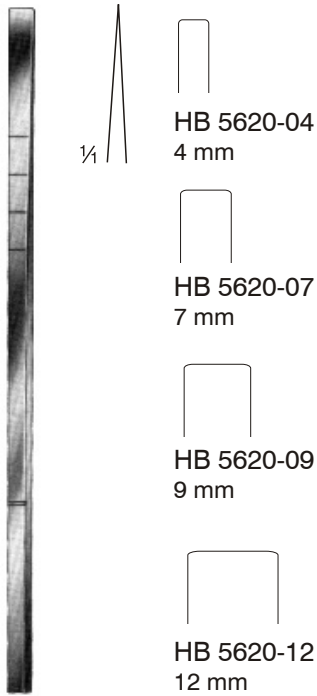

Cottle
 18,0 cm/7"

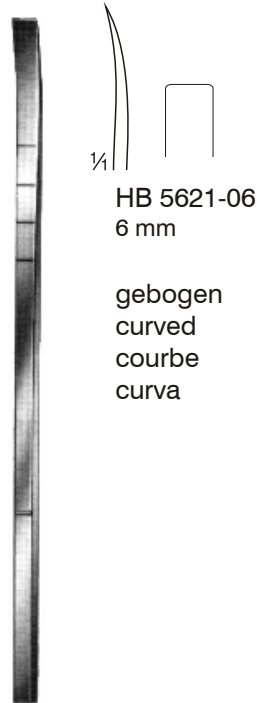

Cottle
 18,0 cm/7"

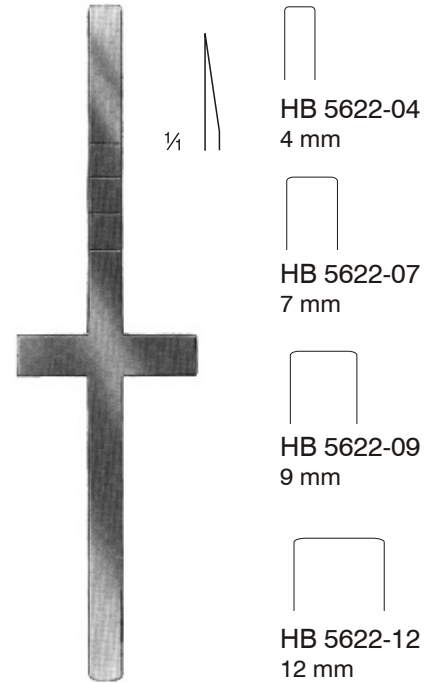

Cottle
 18,0 cm/7"

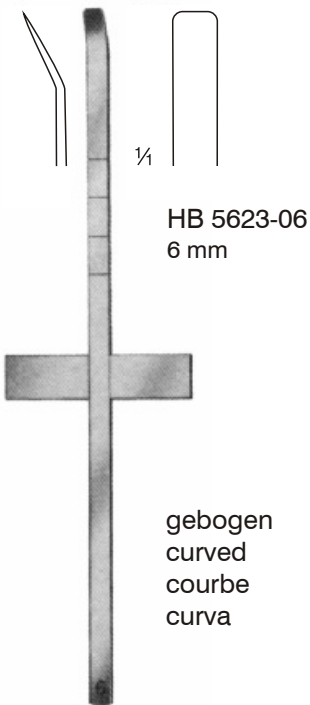

Cottle
 18,0 cm/7"

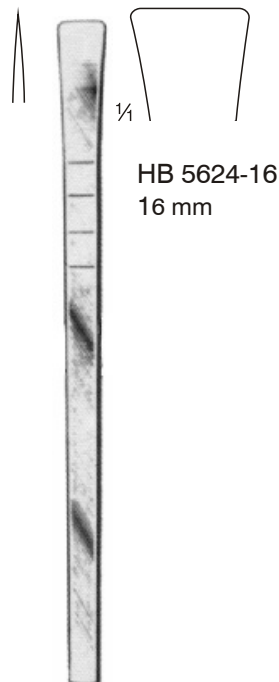

Cottle
 18,0 cm/7"

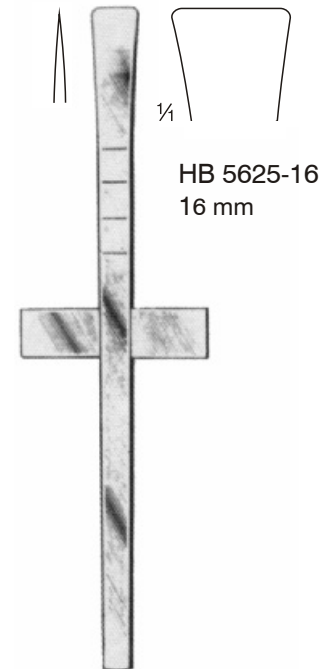

Cottle
 18,0 cm/7"

Nasen-Osteotome
Nasal Osteotomes
Osteotomes nasales
Osteotomos nasales

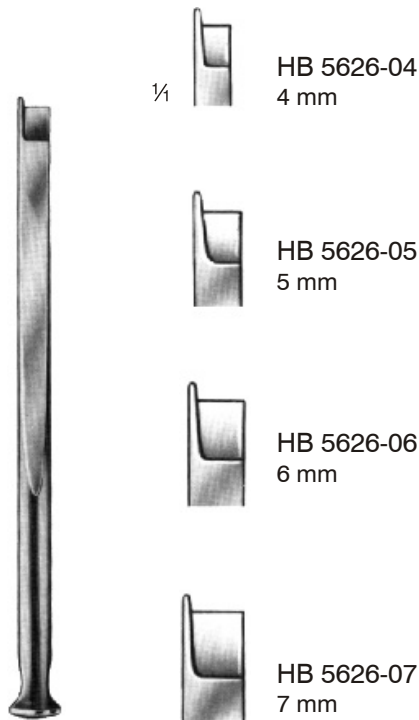

Fomon
 17,0 cm/6³/₄"

1/4 HB 5626-04
 4 mm

HB 5626-05
 5 mm

HB 5626-06
 6 mm

HB 5626-07
 7 mm

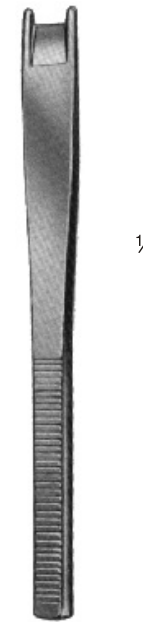

Cinelli
 16,0 cm/6¹/₂"

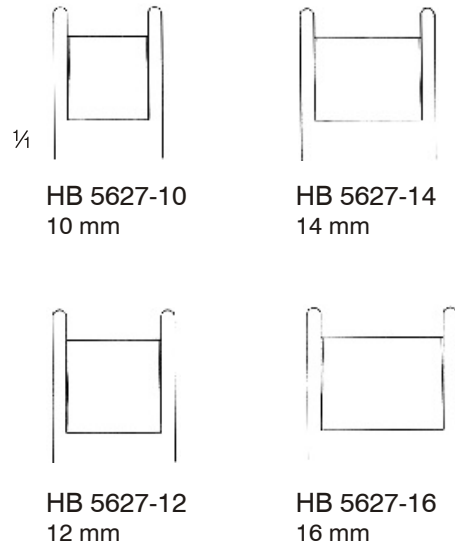

1/4 HB 5627-10
 10 mm

HB 5627-12
 12 mm

HB 5627-14
 14 mm

HB 5627-16
 16 mm

Flachmeißel
Chisel
Ciseaux-burin
Cinzel

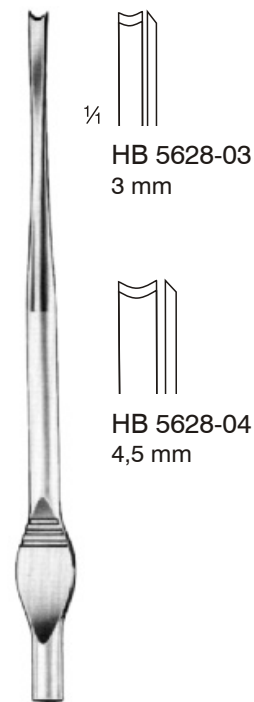

Walter
 19,0 cm/7³/₄"

1/4 HB 5628-03
 3 mm

HB 5628-04
 4,5 mm

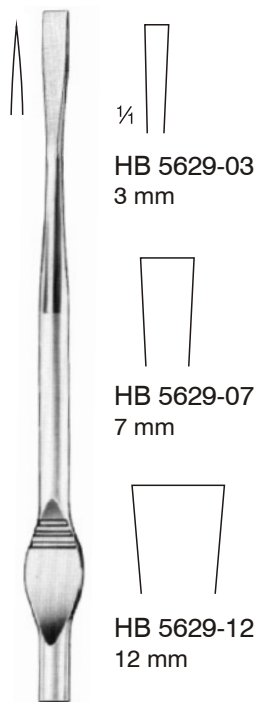

Walter
 19,0 cm/7³/₄"

1/4 HB 5629-03
 3 mm

HB 5629-04
 4 mm

HB 5629-07
 7 mm

HB 5629-09
 9 mm

HB 5629-12
 12 mm



Rubin
 18,0 cm/7"

1/4 HB 5630-10
 10 mm

HB 5630-12
 12 mm

HB 5630-14
 14 mm

Nasen-Osteotome
Nasal Osteotomes
Osteotomes nasales
Osteotomos nasales

Flachmeißel
Chisels
Ciseaux-burins
Cinceles

Septum-Hohlmeißel
Septum Gouges
Septum gouges
Septum gubias



gerade
 straight
 droit
 recto

Silver

HB 5631-01
 18,0 cm/7"



rechts
 right
 à droite
 a la derecha

Silver

HB 5631-02
 18,0 cm/7"

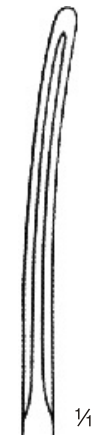

links
 left
 à gauche
 a la izquierda

Silver

HB 5631-03
 18,0 cm/7"

Flachmeißel, Chisels
 Ciseaux-burins, Cinceles

Septum-Hohlmeißel, Septum Gouges, Septum gouges, Septum gubias

4 mm



gerade
 straight
 droit
 recto

Freer

HB 5632-01
 16,0 cm/6½"

4 mm



gebogen
 curved
 courbe
 curvo

Freer

HB 5632-02
 16,0 cm/6½"

6 mm



Freer

HB 5633
 15,0 cm/6"

5 mm



Killian

HB 5634-01
 17,0 cm/6¾"

5 mm



Killian-Claus

HB 5634-02
 17,0 cm/6¾"



Joseph
 19,0 cm/7½"

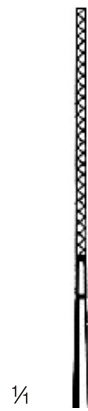

Fig. 1
 HB 5635-01

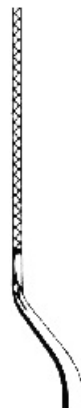

Fig. 2
 HB 5635-02

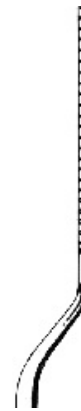

Fig. 3
 HB 5635-03

bajonettförmig
 bayonet-shaped
 en forme de baïonnette
 en forma de bayoneta

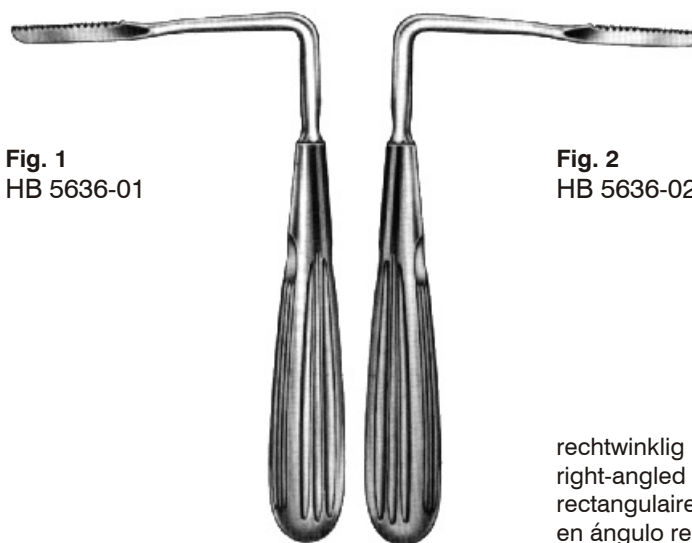
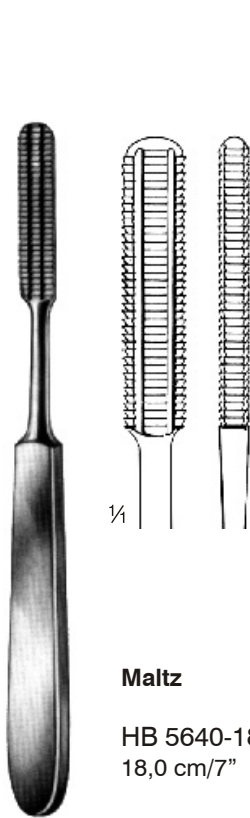

Fig. 1
 HB 5636-01

Fig. 2
 HB 5636-02

rechtwinklig
 right-angled
 rectangulaire
 en ángulo recto

Joseph
 17,0 cm/6¾"



Maltz
 HB 5640-18
 18,0 cm/7"

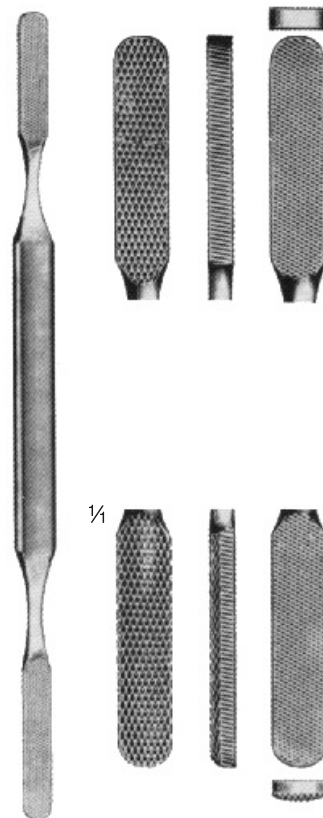

Fomon
 HB 5641-21
 21,0 cm/8¼"

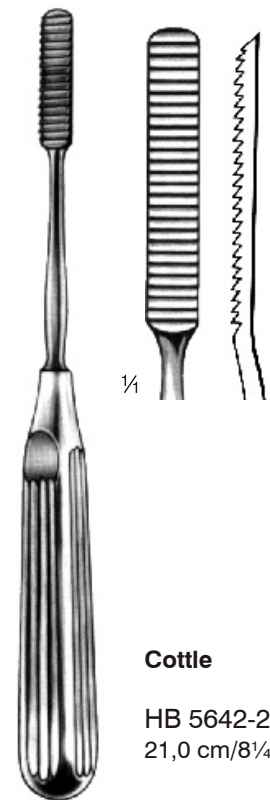

Cottle
 HB 5642-21
 21,0 cm/8¼"

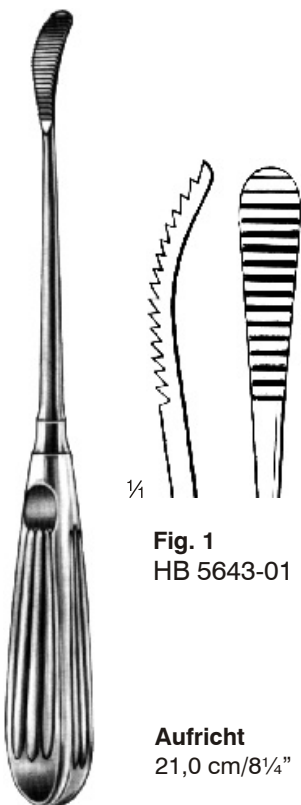

Fig. 1
 HB 5643-01

Aufricht
 21,0 cm/8¼"

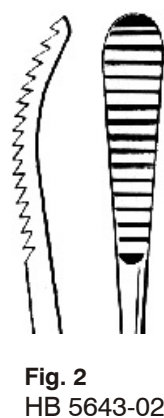

Fig. 2
 HB 5643-02



Fig. 1
 HB 5644-01

Wiener
 18,0 cm/7"



Fig. 2
 HB 5644-02

Nasenflügelhaken
Hooks for posterior nares
Crochets pour les ailes du nez
Separadores nasales

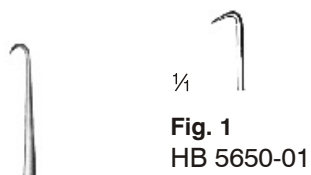

¼

Fig. 1
HB 5650-01

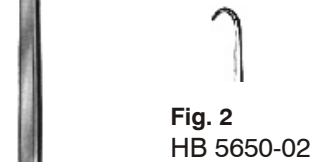

Fig. 2
HB 5650-02

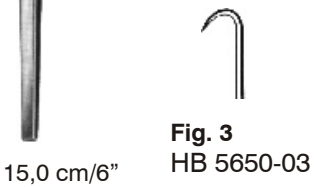

Fig. 3
HB 5650-03

15,0 cm/6"



Joseph

HB 5651-15
15,0 cm/6"



Cottle

HB 5652-16
16,0 cm/6¼"



Choanenhaken
Hook for posterior nares
Crochet boutoné pour
les ailes du nez
Gancho para las coanas

Cottle

HB 5654-22
22,0 cm/8¾"



Fomon

HB 5655-17
17,0 cm/6¾"



Aufricht

HB 5656-19
19,0 cm/7½"



Aufricht

HB 5658-14
13,5 cm/5¼"



Kilner

HB 5659-10
10,0 cm/4"

¼



Converse

HB 5660-12
12,0 cm/4¾"

Nasenflügelhaken
Hooks for posterior nares
Crochets pour les ailes du nez
Separadores nasales



Freer
 HB 5661-15
 15,0 cm/6"



Joseph
 16,0 cm/6¼"



HB 5663-02
 2 mm



HB 5663-05
 5 mm



HB 5663-07
 7 mm



HB 5663-10
 10 mm



Fomon
 HB 5664-16
 16,0 cm/6¼"



Cottle-Neivert
 HB 5665-20
 20,0 cm/8"



Cottle
 15,0 cm/6"

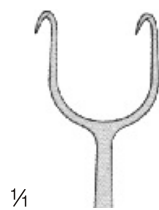

Fig. 1
 HB 5667-01

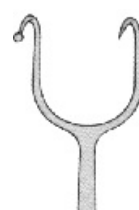

Fig. 2
 HB 5667-02



Fig. 3
 HB 5667-03

Nasenflügelhaken
Hooks for posterior nares
Crochets pour les ailes du nez
Separadores nasales

Schwingmesser
Swivel Knives
Couteaux nasales
Cuchillos para el tabique nasal



Cottle

HB 5668-14
 14,0 cm/5½"

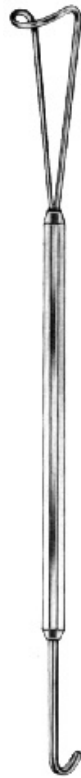

Neivert

HB 5669-16
 16,0 cm/6¼"



Cottle

HB 5670-15
 15,0 cm/6"



Cottle

HB 5671-15
 15,0 cm/6"



Ballenger
 20,0 cm/8"



HB 5680-03
 3 mm



HB 5680-04
 4 mm



HB 5680-05
 5 mm

gerade
 straight
 droit
 recto



Ballenger
 20,0 cm/8"



HB 5681-03
 3 mm



HB 5681-04
 4 mm

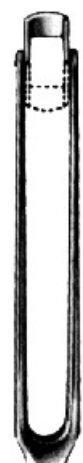

HB 5681-05
 5 mm

bajonettförmig
 bayonet-shaped
 en forme de baïonnette
 en forma de bayoneta

Nasenplastik-Messer
Rhinoplastic and Nasal Knives
Bistouris pour plastique et le nez
Bisturías para plástica y la nariz

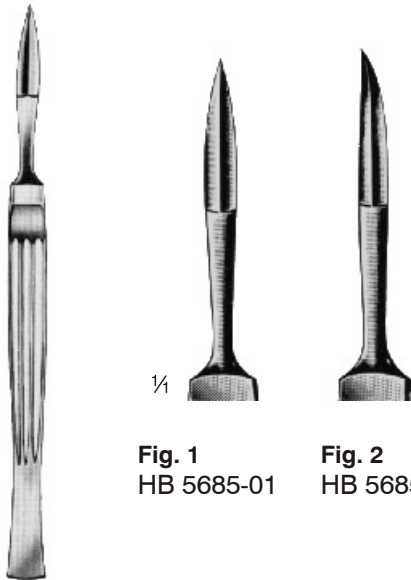

Fig. 1
HB 5685-01

Fig. 2
HB 5685-02

Joseph
15,0 cm/6"



Fomon

HB 5686-16
16,0 cm/6½"



Cottle

HB 5687-15
15,0 cm/6"



Joseph

HB 5688-15
15,0 cm/6"



Converse

HB 5689-16
16,0 cm/6½"



Cottle

HB 5690-15
15,0 cm/6"

**Ringmesser
Adenoid Currettes
Couteaux à végétations adénoïdes
Cuchillas para vegetaciones adenoides**



Vogel
HB 5700
21,0 cm/8 1/4"



Beckmann
22,0 cm/8 3/4"



Fig. 1
HB 5701

Fig. 2
HB 5702

Fig. 3
HB 5703

Fig. 4
HB 5704

Fig. 5
HB 5705



Barnhill
21,0 cm/8 1/4"



Fig. 1
HB 5711

Fig. 2
HB 5712

Fig. 3
HB 5713

Fig. 4
HB 5714



St. Clair-Thomson
21,0 cm/8 1/4"



Fig. 1
HB 5721

Fig. 2
HB 5722

Fig. 3
HB 5723

Fig. 4
HB 5724



La Force
 25,0 cm/10"



Fig. 1



Fig. 2



Fig. 3

¼

mit gelochter Klinge
 with perforated blade
 à lame perforée
 con hoja perforada

- Fig. 1** HB 5731
- Fig. 2** HB 5732
- Fig. 3** HB 5733

Ersatzklingen
 Spare blades
 Lames de rechange
 Hojas de repuesto

- Fig. 1** HB 5735
- Fig. 2** HB 5736
- Fig. 3** HB 5737



Heister

HB 5803
13,0 cm/5"

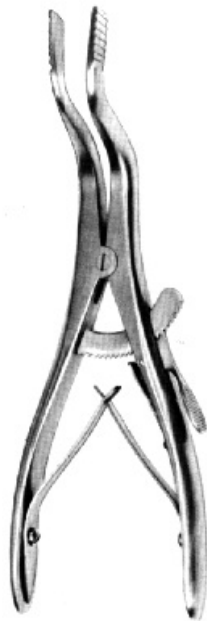

Roser-König

HB 5807
16,0 cm/6¼"



Denhart

HB 5810
12,0 cm/4¾"



Molt

HB 5814 11,0 cm/4½"
HB 5815 14,0 cm/5½"



Whitehead

HB 5821 11,0 cm/4½"
HB 5823 13,0 cm/5"
HB 5825 15,0 cm/6"



Jennings

HB 5830 9,0 cm/3½"
HB 5831 11,0 cm/4½"
HB 5833 13,0 cm/5"
HB 5835 15,0 cm/6"



Davis-Boyle

Zungenspatel allein, Tongue Depressor only
Abaisse-langue seule, Abaja-lengua suelta

Fig. 1
HB 5841
21 x 30 mm

Fig. 2
HB 5842
23 x 65 mm

Fig. 3
HB 5843
24 x 80 mm

Fig. 4
HB 5844
25 x 93 mm

Fig. 5
HB 5845
26 x 108 mm



Davis-Boyle

Griff allein, Handle only
Manche seul, Mango suelto

HB 5840-01	HB 5840-02	HB 5840-03
für Erwachsene	für Jugendliche	für Kinder
for adults	for young people	for children
pour adultes	pour jeunes gens	pour enfants
para adultos	para menores	para niños

HB 5846

Paar Silikoneinlagen allein
Pair of silicon inserts only
Paire de protection translucid seule
Par de silicon piezas solo

Davis-Boyle

HB 5839

Satz, komplett mit:
Griff HB 5840-02, 2 Silikoneinlagen
5 auswechselbaren Zungenspateln HB 5841 - HB 5845

Set, complete with:
handle HB 5840-02, 2 silicon inserts
5 interchangeable tongue depressors HB 5841 - HB 5845

Jeu, complet avec:
manche HB 5840-02, une paire de protection translucid
5 abaisse-langues interchangeables HB 5841 - HB 5845

Juego, completo con:
mango HB 5840-02, un par de silicon piezas
5 abaja-lenguas intercambiables HB 5841 - HB 5845



Mc Ivor

Zungenspatel allein, Tongue Depressor only
Abaisse-langue seule, Abaja-lengua suelta

Fig. 1
HB 5851
23 x 70 mm

Fig. 2
HB 5852
25 x 86 mm

Fig. 3
HB 5853
26 x 100 mm



Mc Ivor

HB 5850
Griff allein, Handle only
Manche seul, Mango suelto

Mc Ivor

HB 5849

Satz, komplett mit:
Griff HB 5850
3 auswechselbaren Zungenspateln HB 5851 - HB 5853

Set, complete with:
handle HB 5850
3 interchangeable tongue depressors HB 5851 - HB 5853

Jeu, complet avec:
manche HB 5850
3 abaisse-langues interchangeables HB 5851 - HB 5853

Juego, completo con:
mango HB 5850
3 abaja-lenguas intercambiables HB 5851 - HB 5853



Negus

Zungenspatel allein, Tongue Depressor only
Abaisse-langue seule, Abaja-lengua suelta

Fig. 1
HB 5861
28 x 70 mm

Fig. 2
HB 5862
30 x 80 mm

Fig. 3
HB 5863
33 x 95 mm



Davis-Boyle

Griff allein, Handle only
Manche seul, Mango suelto

HB 5840-01	HB 5840-02	HB 5840-03
für Erwachsene	für Jugendliche	für Kinder
for adults	for young people	for children
pour adultes	pour jeunes gens	pour enfants
para adultos	para menores	para niños

HB 5846

Paar Silikoneinlagen allein
Pair of silicon inserts only
Paire de protection translucide seule
Par de silicon piezas solo

Negus

HB 5859

Satz, komplett mit:
Griff HB 5840-02, 2 Silikoneinlagen
3 auswechselbaren Zungenspateln HB 5861 - HB 5863

Set, complete with:
handle HB 5840-02, 2 silicon inserts
3 interchangeable tongue depressors HB 5861 - HB 5863

Jeu, complet avec:
manche HB 5840-02, une pair de protection translucide compris
3 abaisse-langues interchangeables HB 5861 - HB 5863

Juego, completo con:
mango HB 5840-02, un par de silicon piezas
3 abaja-lenguas intercambiables HB 5861 - HB 5863

Kilner-Doughty (Russel-Davis)

Zungenspatel allein, Tongue Depressor only
Abaisse-langue seule, Abaja-lengua suelta



Fig. 1
HB 5871
28 x 65 mm

Fig. 2
HB 5872
32 x 75 mm

Fig. 3
HB 5873
37 x 80 mm

Fig. 4
HB 5874
40 x 90 mm

Fig. 5
HB 5875
45 x 100 mm



Kilner-Doughty (Russel-Davis)

HB 5870
Griff allein, Handle only
Manche seul, Mango suelto

Kilner-Doughty (Russel-Davis)

HB 5869

Satz, komplett mit:
Griff HB 5870
3 auswechselbaren Zungendrückern HB 5871 - HB 5873
2 beweglichen auswechselbaren Zahnplatten
1 Gaumenplatte für Zahnlose

Set, complete with:
handle HB 5870
3 interchangeable tongue depressors HB 5871 - HB 5873
2 adjustable and exchangeable tooth plates
1 palatal support for toothless people

Jeu, complet avec:
manche HB 5870
3 abaisse-langues interchangeables HB 5871 - HB 5873
2 supports mobiles et interchangeables des dents
1 support du palais pour édentés

Juego, completo con:
mango HB 5870
3 abaja-lenguas intercambiables HB 5871 - HB 5873
2 soportes de dientes móviles e intercambiables
1 soporte de paladar para desdentados

**Zungenspatel
Tongue Depressors
Abaisse-langues
Abaja-lenguas**

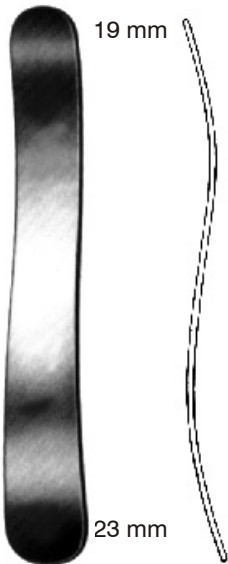

HB 5883
14,0 cm/5½"

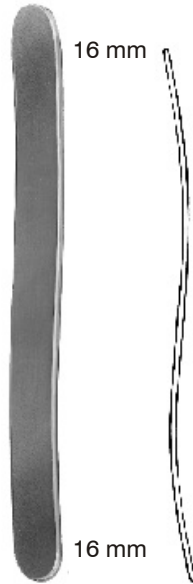

Buchwald
HB 5884
14,5 cm/5¾"

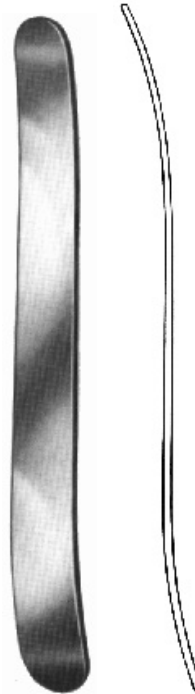

Buchwald
HB 5888
18,0 cm/7"



Bruenings
HB 5890
19,0 cm/7½"



massiv
solid
massif
macizo

Tobold
HB 5891
14,5 cm/5¾"

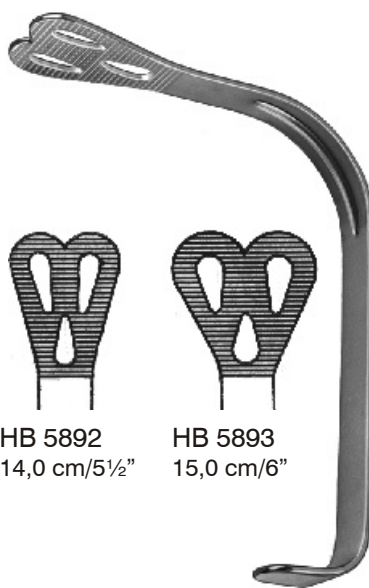

HB 5892
14,0 cm/5½"

HB 5893
15,0 cm/6"

Wieder



Doyen

HB 5894 13,0 cm/5"
HB 5895 16,0 cm/6¼"



Andrew

HB 5896
11,0 cm/4½"



Collin

HB 5900 17,0 cm/6 $\frac{3}{4}$ "
HB 5901 19,0 cm/7 $\frac{1}{2}$ "



Young

HB 5907 16,0 cm/6 $\frac{1}{4}$ "

HB 5907-02

Paar Ersatzgummi
Pair of replacement rubber inserts
Paire de caoutchouc de rechange
Par de goma de recambio

Tonsillenzangen
Tonsil Seizing Forceps
Pinces à préhension des amygdales
Pinzas para coger las amígdalas

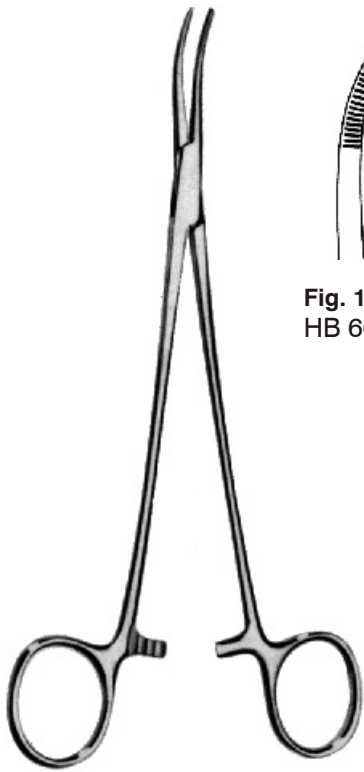

Fig. 1
HB 6001



Fig. 2
HB 6002



Schnidt
19,0 cm/7½"



Fig. 1
HB 6003



Fig. 2
HB 6004



Schnidt
19,0 cm/7½"

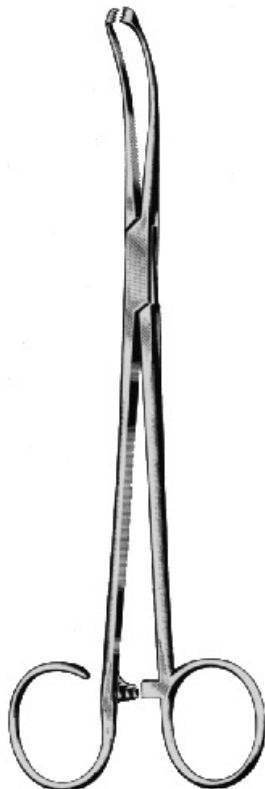

White

HB 6005
18,0 cm/7"



Blohmke

HB 6006
20,0 cm/8"



Tonsillenschnürer
Tonsil Snares
Serre-noeuds pour l'ablation des amygdales
Cierra-nudos para amígdalas



Bruenings

HB 6010
 28,0 cm/11"



Eves

HB 6011
 28,0 cm/11"



Eves

HB 6012
 28,0 cm/11"

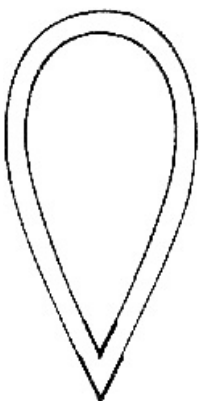

HB 6010-40 0,4 mmØ/40 mm
 HB 6010-50 0,4 mmØ/50 mm
 Drahtschlingen gelötet für Bruenings
 (Bündel à 100 Stück)
 Snare wires for Bruenings, soldered
 (package of 100 pieces)
 Anses soudées pour Bruenings
 (paquet à 100 pièces)
 Asas soldadas para Bruenings
 (paquete con 100 piezas)



HB 6018 0,3 mmØ/100 mm
 HB 6019 0,3 mmØ/90 mm
 Drahtschlingen, geschnitten
 (Pack à 12 Stück)
 Snare wires, cut
 (pack of 12 pieces)
 Anses coupées
 (paquet à 12 pièces)
 Asas preparadas
 (paquete con 12 piezas)

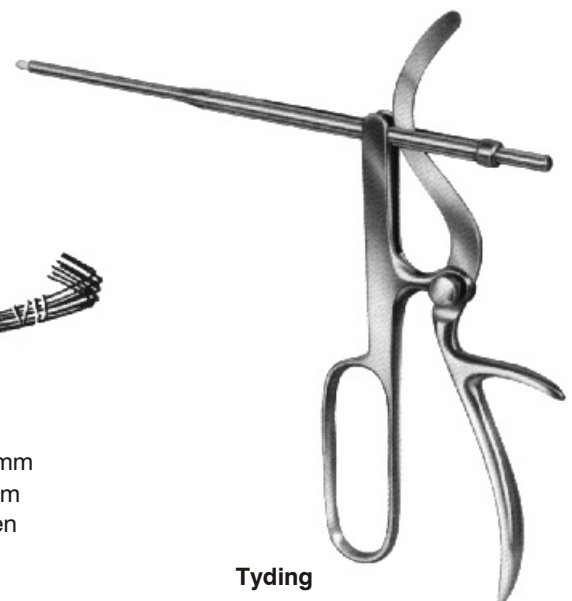

Tyding

HB 6013
 mit 1 geraden Aufsatz
 with 1 straight tip
 avec 1 guía-ansa droit
 con 1 guía-asa recta

Tonsillennmesser, -dissektoren, -enukleatoren, -retraktoren
Tonsil Knives, Dissectors, Enucleators, Retractors
Bistouris pour amygdales, Dissecteurs, Enucleateurs, Ecarteurs
Bisturías para amígdalas, Disecadores, Enucleadores, Separadores



Tonsillennmesser und -enukleator
 Tonsil Knives and Enucleators
 Bistouris et Enucleateurs pour amygdales
 Bisturías y Enucleadores para amígdalas

Carpenter

HB 6020-01
 25,0 cm/10"

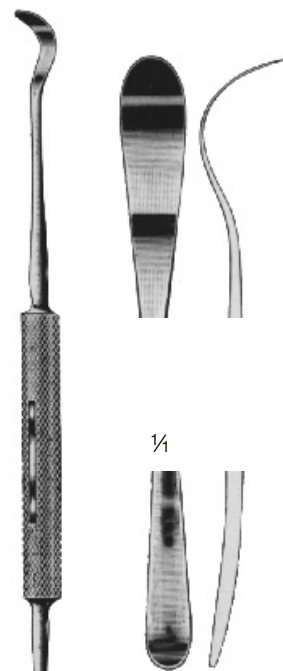

Carpenter

HB 6020-02
 24,0 cm/9½"



Tonsillendissektor und -retractor
 Tonsil Dissector and Retractor
 Dissecteur et Retracteur pour amygdales
 Disecador y Separador para amígdalas

Hurd

HB 6021
 22,5 cm/9"

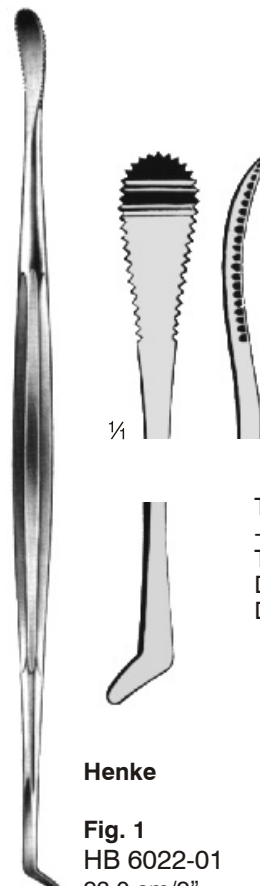

Tonsillendissektor und
 -separator
 Tonsil Dissector
 Dissecteur pour amygdales
 Disecador para amígdalas

Henke

Fig. 1
 HB 6022-01
 23,0 cm/9"

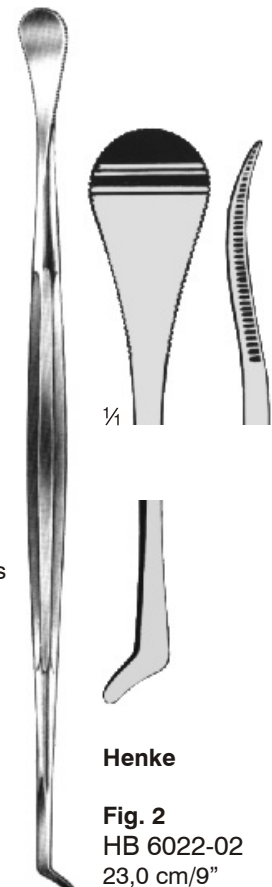

Henke

Fig. 2
 HB 6022-02
 23,0 cm/9"



Fig. 1



Fig. 2



Fig. 3



Sluder-Ballenger

Sluder-Ballenger

HB 6025
mit Aufsatz Fig. 1
with tip Fig. 1
avec lame Fig. 1
con hoja Fig. 1

HB 6026
mit Aufsatz Fig. 1, Fig. 2
with tip Fig. 1, Fig. 2
avec lame Fig. 1, Fig. 2
con hoja Fig. 1, Fig. 2

HB 6027
mit Aufsatz Fig. 1, Fig. 2, Fig. 3
with tip Fig. 1, Fig. 2, Fig. 3
avec lame Fig. 1, Fig. 2, Fig. 3
con hoja Fig. 1, Fig. 2, Fig. 3

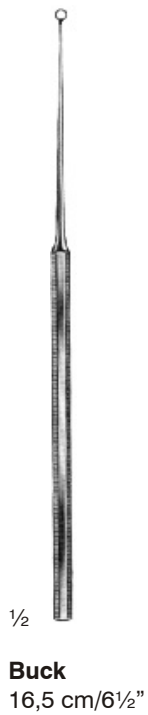

gerade, straight, droite, recta

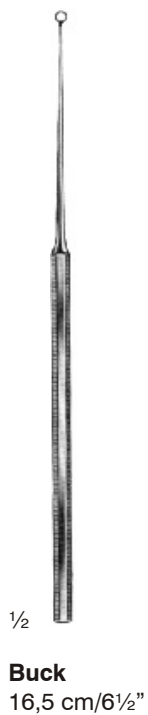
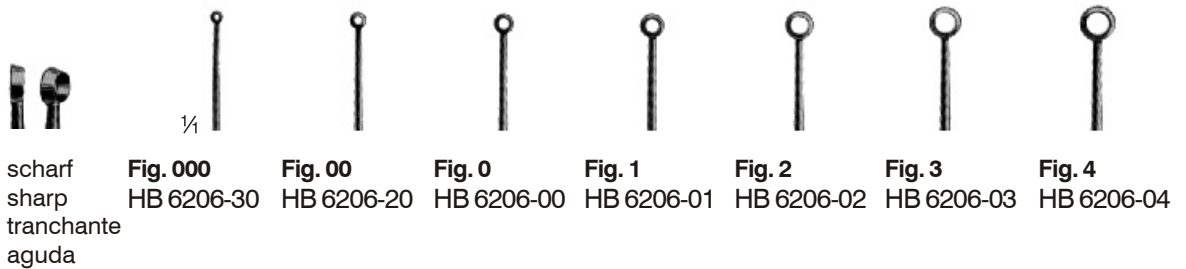
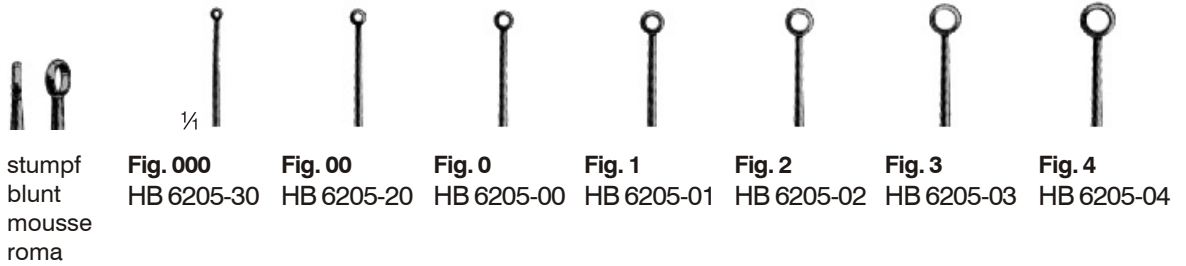

gebogen, curved, courbe, curva

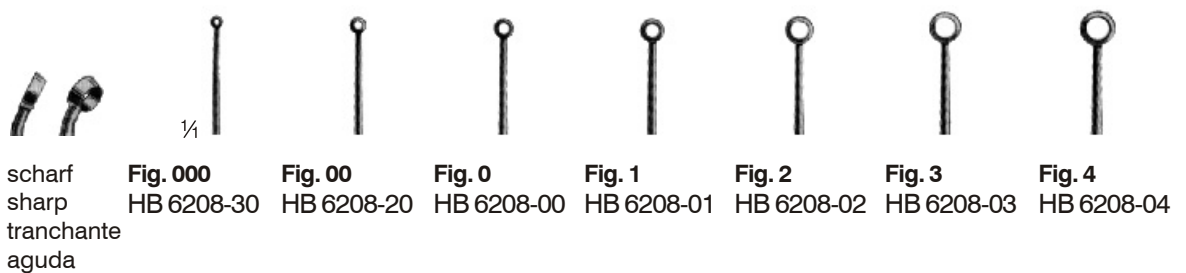
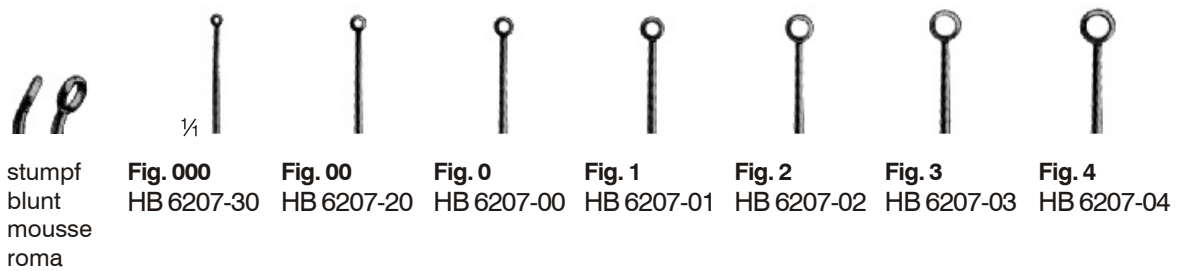

Ohrküretten
 Ear Curettes
 Curettes auriculaires
 Curetas auriculares

Oherschlingen
 Ear Loops
 Anses auriculaires
 Asas auriculares

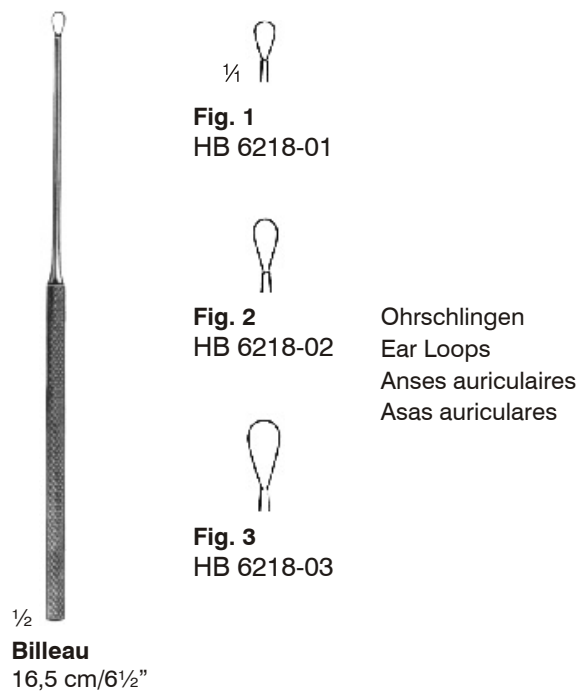
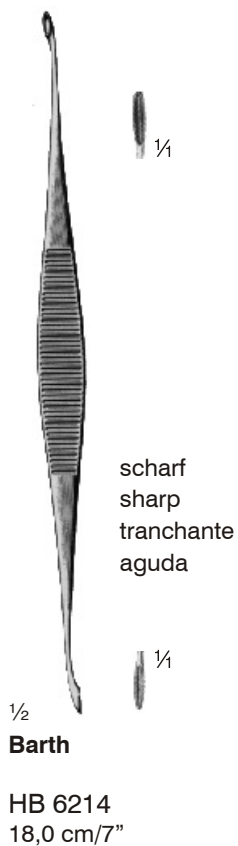
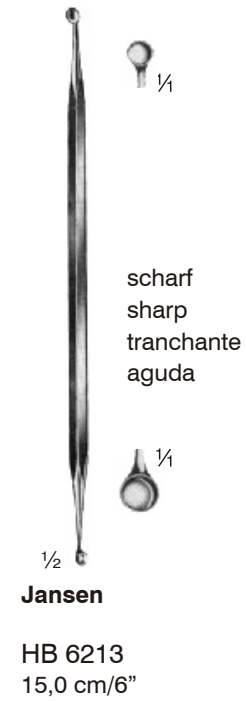
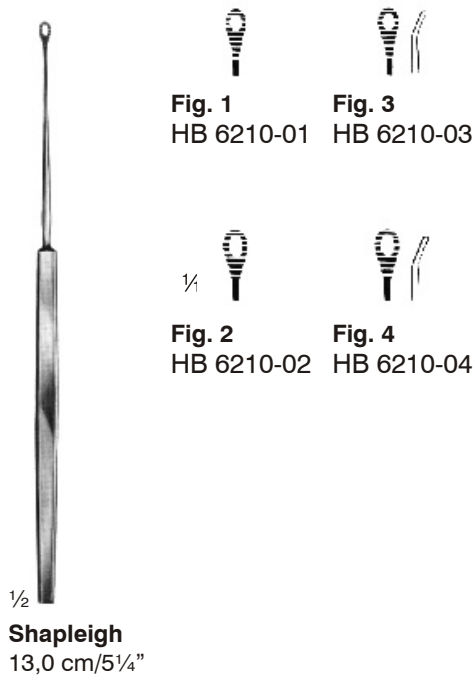

Ohrhäkchen

Ear Hooks

Crochets auriculaires

Ganchos auriculares

Diverse Ohrinstrumente

Miscellaneous Ear Instruments

Instruments divers pour les oreilles

Instrumentos diversos para orejas

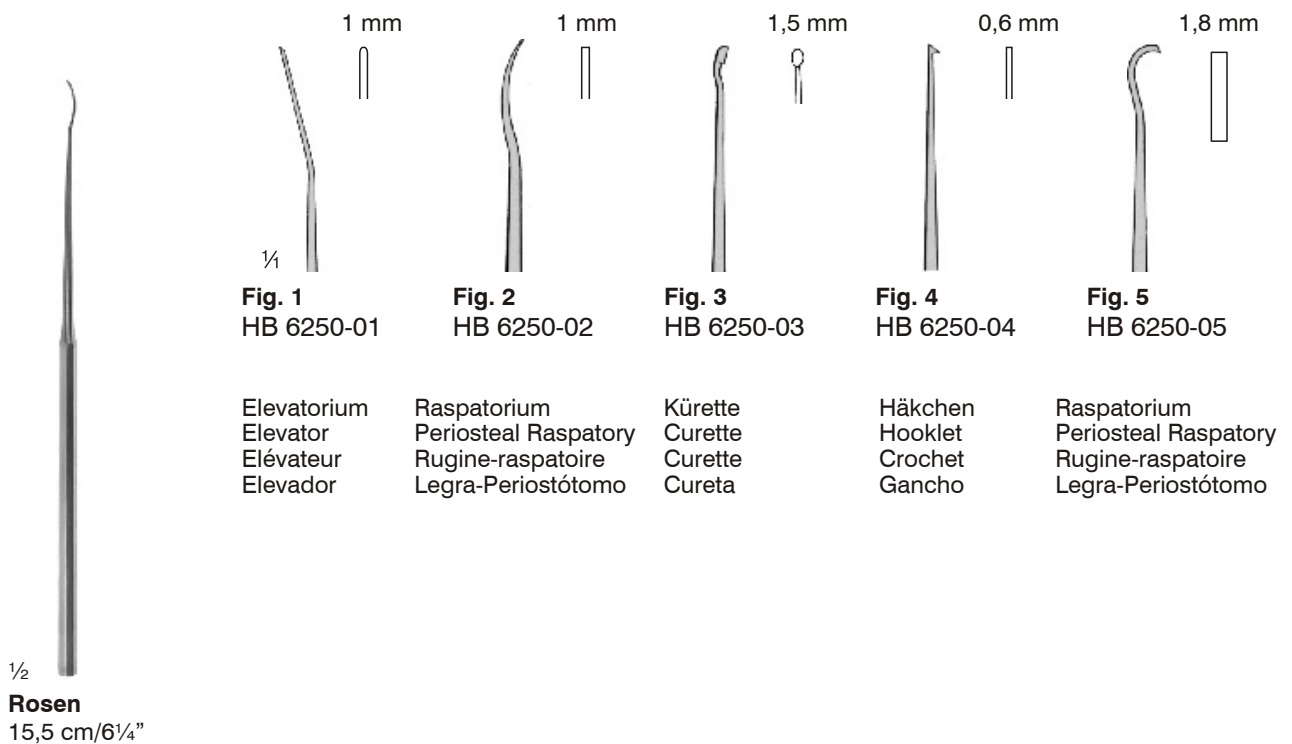
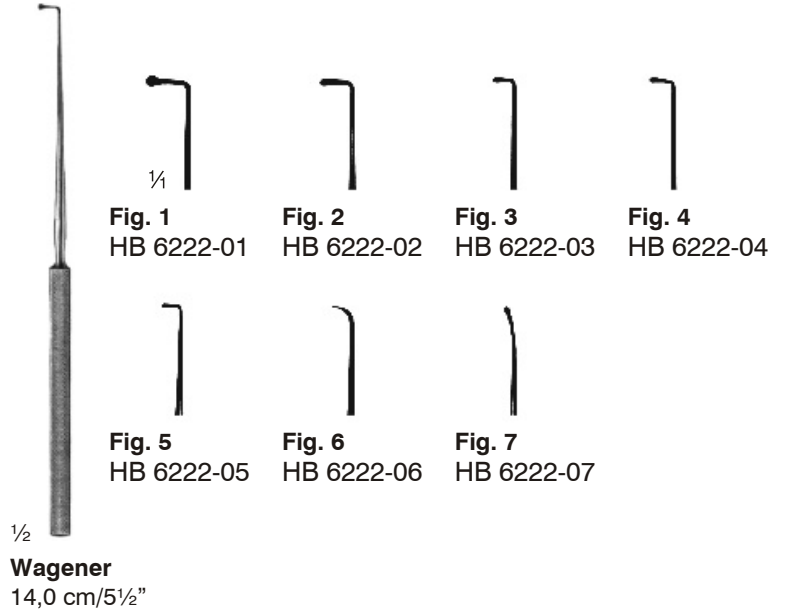
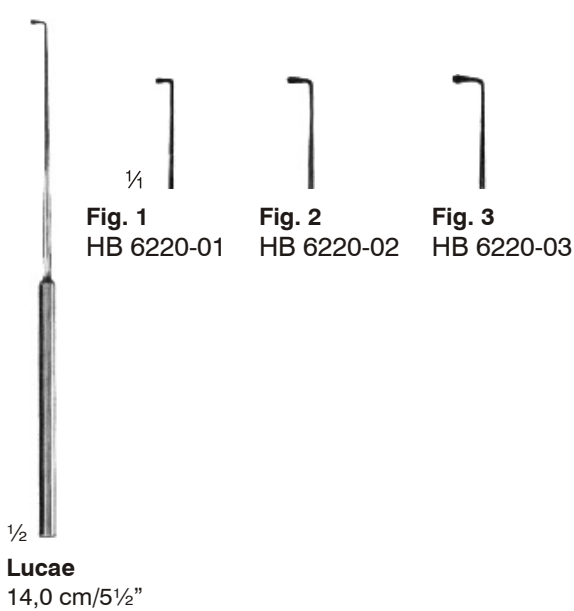

Parazentesenadeln
 Paracentesis Needles
 Aiguilles à paracentèse
 Agujas para paracentesis

Trommelfellmesser
 Tympanum Knives
 Couteaux à tympan
 Cuchillos para tímpano



Parazentesenadeln, Paracentesis Needles, Aiguilles à paracentèse, Agujas para paracentesis



Lucae(Royce)

Fig. 1
 HB 6290-01
 18,0 cm/7"

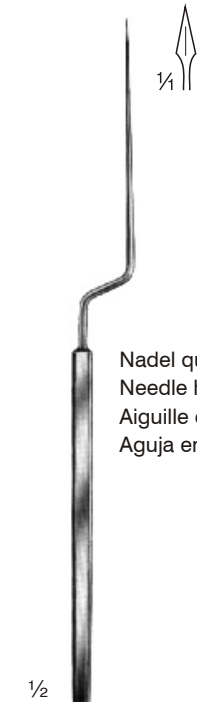

Lucae(Royce)

Fig. 2
 HB 6290-02
 18,0 cm/7"

Nadel quergestellt
 Needle horizontal position
 Aiguille en position horizontale
 Aguja en posición horizontal

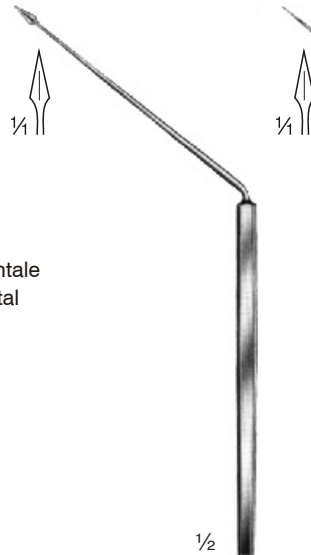

Politzer

Fig. 1
 HB 6291-01
 16,5 cm/6½"

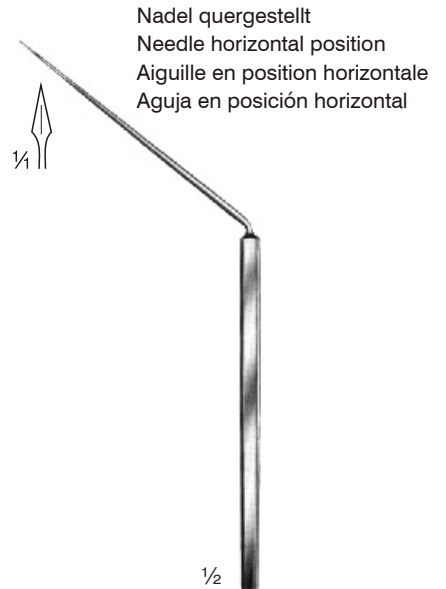

Politzer

Fig. 2
 HB 6291-02
 16,5 cm/6½"

Nadel quergestellt
 Needle horizontal position
 Aiguille en position horizontale
 Aguja en posición horizontal

Trommelfellmesser, Tympanum Knives, Couteaux à tympan, Cuchillos para tímpano



Sexton

Fig. 1
 HB 6298-01
 18,0 cm/7"



Sexton

Fig. 2
 HB 6298-02
 17,0 cm/6¾"



Sexton

Fig. 3
 HB 6298-03
 17,0 cm/6¾"

Ohrzangchen
Ear Polypus Forceps
Pinces pour polypes auriculaires
Pinzas para polipos

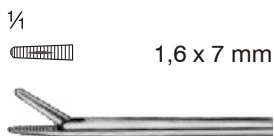
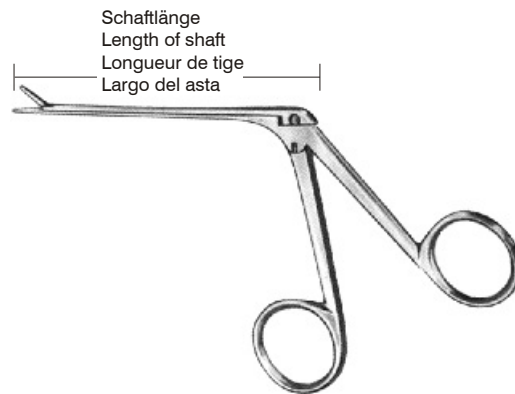

Hartmann-Wullstein
 HB 6400 8,5 cm/3 3/4"
 Schaftlange
 Length of shaft
 Longueur de tige
 Largo del asta

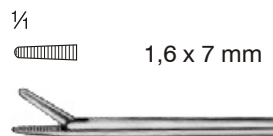

Hartmann
 HB 6401-08 8,0 cm/3 1/2"
 HB 6401-14 14,0 cm/5 1/2"
 HB 6401-16 16,0 cm/6 1/4"
 Schaftlange
 Length of shaft
 Longueur de tige
 Largo del asta

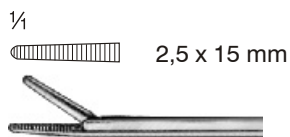

Hartmann-Noyes
 HB 6406 8,0 cm/3 1/2"
 Schaftlange
 Length of shaft
 Longueur de tige
 Largo del asta

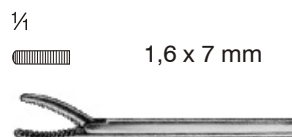

Hartmann-Weingartner
 HB 6407 8,0 cm/3 1/2"
 Schaftlange
 Length of shaft
 Longueur de tige
 Largo del asta

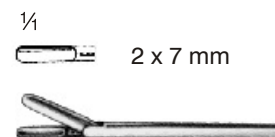

Hartmann
 HB 6408 8,0 cm/3 1/2"
 Schaftlange
 Length of shaft
 Longueur de tige
 Largo del asta

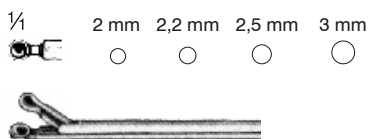

Loffelmaul
 Spoon-shaped jaw
 Mors en forme d'un cuiller
 Boca en forma de cucharilla

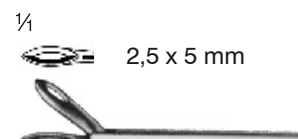

Struempel
 HB 6410 8,0 cm/3 1/2"
 Schaftlange
 Length of shaft
 Longueur de tige
 Largo del asta

Hartmann-Noyes
 HB 6409-20 2 mm 8,0 cm/3 1/2"
 HB 6409-22 2,2 mm Schaftlange
 HB 6409-25 2,5 mm Length of shaft
 HB 6409-30 3 mm Longueur de tige
 Largo del asta

Ohrzangchen
Ear Polypus Forceps
Pinces pour polypes auriculaires
Pinzas para p6lipos

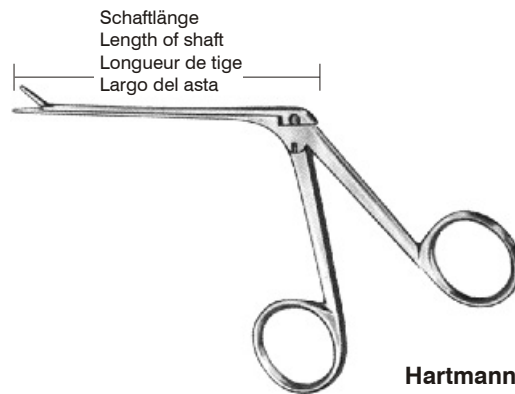

Hartmann

mittelfein

Schaft 1,2 x 1,8 mm
 Shaft 1,2 x 1,8 mm
 Tige 1,2 x 1,8 mm
 Asta 1,2 x 1,8 mm

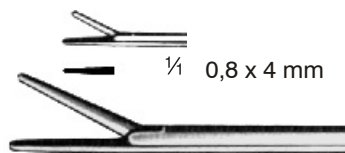

HB 6420-01 7,5 cm/3"
 glatt
 smooth
 lisse
 lisa
 Schaftlange
 Length of shaft
 Longueur de tige
 Largo del asta

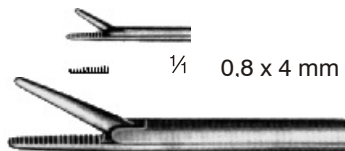

HB 6421-01 7,5 cm/3"
 gerieft
 serrated
 stri6
 estriada
 Schaftlange
 Length of shaft
 Longueur de tige
 Largo del asta

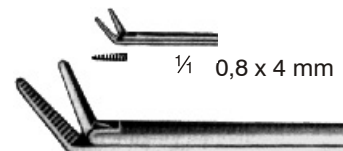

HB 6421-02 7,5 cm/3"
 gerieft
 serrated
 stri6
 estriada
 Schaftlange
 Length of shaft
 Longueur de tige
 Largo del asta

Schaft 1,8 x 2,6 mm
 Shaft 1,8 x 2,6 mm
 Tige 1,8 x 2,6 mm
 Asta 1,8 x 2,6 mm

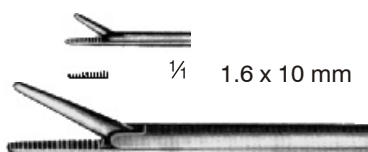

HB 6422 8,0 cm/3 1/2"
 gerieft
 serrated
 stri6
 estriada
 Schaftlange
 Length of shaft
 Longueur de tige
 Largo del asta

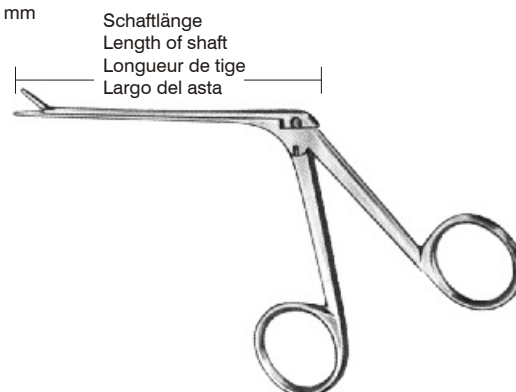

Bellucci

Mikro-Ohrzangchen
Micro Ear Polypus Forceps
Micro-Pinces pour polypes auriculaires
Micro-Pinzas para p6lipos

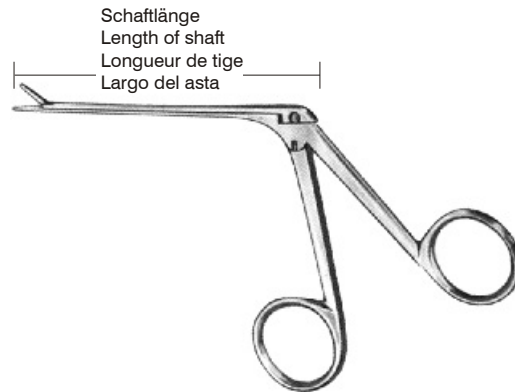

sehr fein

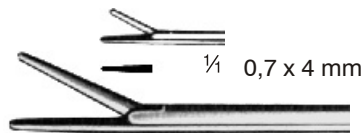

HB 6430-01 8,0 cm/3 1/2"
 glatt
 smooth
 lisse
 lisa
 Schaftlange
 Length of shaft
 Longueur de tige
 Largo del asta

Schaft 0,8 x 1,8 mm
 Shaft 0,8 x 1,8 mm
 Tige 0,8 x 1,8 mm
 Asta 0,8 x 1,8 mm

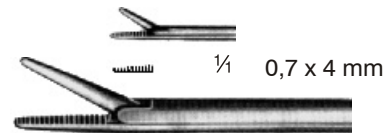

HB 6430-02 8,0 cm/3 1/2"
 gerieft
 serrated
 stri6
 estriada
 Schaftlange
 Length of shaft
 Longueur de tige
 Largo del asta

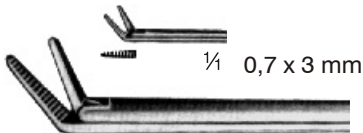

HB 6430-03 8,0 cm/3 1/2" nach oben abgewinkelt
 gerieft
 serrated
 stri6
 estriada
 Schaftlange
 Length of shaft
 Longueur de tige
 Largo del asta
 angular upwards
 coud6e vers le haut
 angulada hacia arriba

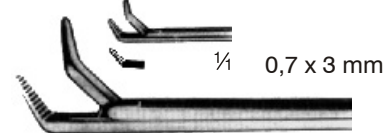

HB 6430-04 8,0 cm/3 1/2" nach rechts abgewinkelt
 gerieft
 serrated
 stri6
 estriada
 Schaftlange
 Length of shaft
 Longueur de tige
 Largo del asta
 angular to the right
 coud6e vers la droite
 angulada a la derecha

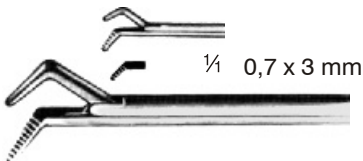

HB 6430-05 8,0 cm/3 1/2" nach links abgewinkelt
 gerieft
 serrated
 stri6
 estriada
 Schaftlange
 Length of shaft
 Longueur de tige
 Largo del asta
 angular to the left
 coud6e vers la gauche
 angulada a la izquierda

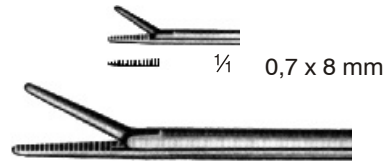

HB 6430-06 8,0 cm/3 1/2"
 gerieft
 serrated
 stri6
 estriada
 Schaftlange
 Length of shaft
 Longueur de tige
 Largo del asta

superfein

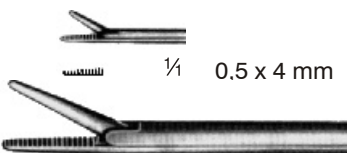

HB 6431-01 8,0 cm/3 1/2"
 gerieft
 serrated
 stri6
 estriada
 Schaftlange
 Length of shaft
 Longueur de tige
 Largo del asta

Schaft 0,6 x 1,5 mm
 Shaft 0,6 x 1,5 mm
 Tige 0,6 x 1,5 mm
 Asta 0,6 x 1,5 mm

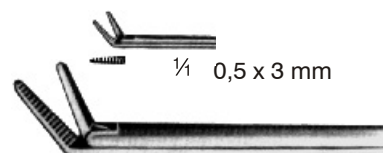

HB 6431-02 8,0 cm/3 1/2" nach oben abgewinkelt
 gerieft
 serrated
 stri6
 estriada
 Schaftlange
 Length of shaft
 Longueur de tige
 Largo del asta
 angular upwards
 coud6e vers le haut
 angulada hacia arriba

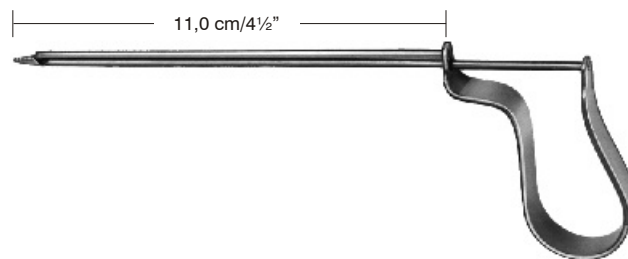

Buck

HB 6466
11,0 cm/4 1/2"

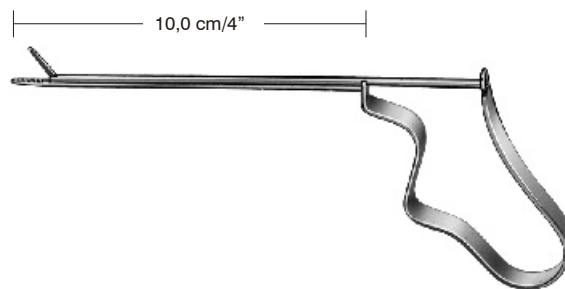

Quire

HB 6467
10,0 cm/4"

