

**HAEBERLE**

multifunctional medical  
cart systems ...and more

**fuego**

the new equipment  
cart system  
with a powerful  
design

**type list**

valid up from 1 July 2007





## the new equipment cart system with a powerful design

### There are many good reasons for choosing fuego:

In the medical sector, fuego equipment carts are ideally suited for the mobile and flexible accommodation of smaller equipment, as computer carts, desks with convenient height adjustment, as ergometry carts, occasional carts, etc..

They are also suitable for use in all types of offices and meeting rooms where the elegant fuego carts offer mobile solutions, e.g. for video presentations, as mobile lecterns, as occasional carts, etc..

In addition to high functionality, the exceptional design and discreet colours of fuego equipment carts are also convincing. They are versatile, flexible, very sturdy and offer plentiful storage on a small footprint. Ideal for small rooms or anywhere requiring a large amount of storage in a small space.

fuego is protected with a European design patent and offers reliable brand quality at a reasonable price!

**NEW!**  
**Beautifully  
designed drawer**

**HAEBERLE specialises in particular in providing customized OEM versions for industrial customers. Let us know your specifications and we will provide you with fuego equipment carts accented in your company colours, featuring your logo on the chassis and adapted to carry your equipment. Please contact us!**



### Note:

If you wish to accommodate larger or heavier equipment and if you are looking for an even more flexible cart system, e.g. with drawers and a wide range of accessories, then we also have the perfect solution:

**The swingo® and swingo®-clinic equipment cart systems!**

Please request documentation.

### The components:

- sturdy and very versatile chassis frame with high-grade quality castors (front castors lockable and fitted with wall deflectors),
- stable single-support aluminium profile for multiple socket boards, with large integrated cable channel for optimal accommodation of cables
- high-quality trays with shaped edge and recessed grip
- beautifully designed drawer
- elegant, steplessly adjustable and tilted desk shelves with roll protection for use, e.g. as mobile desk for lectures, presentations etc.
- console shelves for small devices with stepless height adjustment
- produced as standard with ergonomic handle
- produced as standard with additional grey plastic cable storage clip, fixed to the rear of the profile
- accessories for particular purposes, e.g. as ergometry cart.

### Technical details and dimensions:

Exterior cart dimensions:	531 x 560 x 977 mm (w x d x h) and 531 x 560 x 1127 mm (w x d x h)
Complete load limit of equipment cart:	60 kg
Aluminium profile height:	800 mm or 950 mm
Front castor diameter:	65 mm (lockable)
Rear castor diameter:	125 mm (fixed)
Electrically conductive castors:	available at additional charge
Trays external dimensions:	501 x 386 x 54.8 mm (w x d x h)
Trays footprint dimensions:	approx. 465 x 340 mm (w x d)
Desk shelves external dimensions:	495 x 542 x 18 mm (w x d x h)
Desk shelves tilt:	20°
Console shelves external dimensions:	431 x 330 x 15 mm (w x d x h)
Load limit trays/desk shelves/console shelves:	approx. 15 kg
Drawer external dimensions:	494 x 386 x 131 mm (w x d x h)

### Materials and colours

Mount profile:	Anodised aluminium
Profile canopy/cover:	Plastic, ABS, grey (6502B in accordance with NCS)
Chassis frame:	Aluminium sand-cast, powder-coated grey (6502B in accordance with NCS), fine structure
Decorative strips in the profile from PVC in the following colours:	grey (6502B in accordance with NCS) blue (3050-R80B in accordance with NCS) red-violet (3050-R40B in accordance with NCS) yellow (0050-Y in accordance with NCS) turquoise (1050-B50G in accordance with NCS)
Handle / Rail:	Steel tube, high-grade powder-coated RAL 9006 (white aluminium)
Trays:	high-grade and easy-care plastic, ABS, grey
Desk shelves:	multiplex, stable hard-wearing laminate wood, birch, grey stain, 18 mm thick
Console shelves:	MDF (medium-density fibreboard) with a particularly fine surface, painted grey, 15 mm thick
Drawer:	ABS oriongrey with polished surface

Item	Description	Ref no
------	-------------	--------

## Equipment Carts

All equipment carts are delivered ready assembled. Dimensions, material and technical details see page 3.

**fuego 1  
with drawer**

**new**



**977 mm high, with 1 drawer,  
with 1 tray and pushing handle.**

Colour of decorative strips:

grey	<b>1937.1</b>
blue	<b>1937.2</b>
violet red	<b>1937.3</b>
yellow	<b>1937.4</b>
turquoise	<b>1937.5</b>

**fuego 1**



**977 mm high, with 1 tray and  
pushing handle.**

Colour of decorative strips:

grey	<b>1906.1</b>
blue	<b>1906.2</b>
violet red	<b>1906.3</b>
yellow	<b>1906.4</b>
turquoise	<b>1906.5</b>

**fuego 2**



**977 mm high, with 2 trays and  
pushing handle.**

Colour of decorative strips:

grey	<b>1907.1</b>
blue	<b>1907.2</b>
violet red	<b>1907.3</b>
yellow	<b>1907.4</b>
turquoise	<b>1907.5</b>

**fuego 3**



**977 mm high, with 1 tray, socket board  
with 4 sockets and pushing handle.**

Colour of decorative strips:

grey	<b>1908.1</b>
blue	<b>1908.2</b>
violet red	<b>1908.3</b>
yellow	<b>1908.4</b>
turquoise	<b>1908.5</b>

**fuego 4**



**977 mm high, with 2 trays, socket board  
with 4 sockets and pushing handle.**

Colour of decorative strips:

grey	<b>1909.1</b>
blue	<b>1909.2</b>
violet red	<b>1909.3</b>
yellow	<b>1909.4</b>
turquoise	<b>1909.5</b>







**fuego 5**





**1127 mm high, with 2 trays, socket board  
with 4 sockets and pushing handle.**

Colour of decorative strips:

grey	<b>1910.1</b>
blue	<b>1910.2</b>
violet red	<b>1910.3</b>
yellow	<b>1910.4</b>
turquoise	<b>1910.5</b>

Item	Description	Ref no											
fuego 6		<p><b>1127 mm high, with 3 trays, socket board with 4 sockets and pushing handle.</b></p> <p>Colour of decorative strips:</p> <table border="0"> <tr><td>grey</td><td>1911.1</td></tr> <tr><td>blue</td><td>1911.2</td></tr> <tr><td>violet red</td><td>1911.3</td></tr> <tr><td>yellow</td><td>1911.4</td></tr> <tr><td>turquoise</td><td>1911.5</td></tr> </table>	grey	1911.1	blue	1911.2	violet red	1911.3	yellow	1911.4	turquoise	1911.5	
grey	1911.1												
blue	1911.2												
violet red	1911.3												
yellow	1911.4												
turquoise	1911.5												
fuego 7		<p><b>1050 mm high (height of profile 800 mm), with 2 trays, 1 console shelf with mechanical height adjustment (adjustment height up to 300 mm) and pushing handle.</b></p> <p>Colour of decorative strips:</p> <table border="0"> <tr><td>grey</td><td>1915.1</td></tr> <tr><td>blue</td><td>1915.2</td></tr> <tr><td>violet red</td><td>1915.3</td></tr> <tr><td>yellow</td><td>1915.4</td></tr> <tr><td>turquoise</td><td>1915.5</td></tr> </table>	grey	1915.1	blue	1915.2	violet red	1915.3	yellow	1915.4	turquoise	1915.5	
grey	1915.1												
blue	1915.2												
violet red	1915.3												
yellow	1915.4												
turquoise	1915.5												
fuego desk cart		<p><b>1070 mm high (height of profile 800 mm), with 1 tray, 1 desk shelf with mechanical height adjustment (adjustment height up to 300 mm) and pushing handle.</b></p> <p>Colour of decorative strips:</p> <table border="0"> <tr><td>grey</td><td>1914.1</td></tr> <tr><td>blue</td><td>1914.2</td></tr> <tr><td>violet red</td><td>1914.3</td></tr> <tr><td>yellow</td><td>1914.4</td></tr> <tr><td>turquoise</td><td>1914.5</td></tr> </table>	grey	1914.1	blue	1914.2	violet red	1914.3	yellow	1914.4	turquoise	1914.5	
grey	1914.1												
blue	1914.2												
violet red	1914.3												
yellow	1914.4												
turquoise	1914.5												
fuego computer trolley 2		<p><b>1435 mm high, with a 75 and 100 mm VESA standard TFT screen mount, with a keyboard branch provided with a mouse pull-out; both attached to a height-adjustable column, with an extra shelf, a multipoint socket outlet with 4 sockets and a sliding handle.</b></p> <p>colour of decorative strips:</p> <table border="0"> <tr><td>grey</td><td>1928.1</td></tr> <tr><td>blue</td><td>1928.2</td></tr> <tr><td>violet red</td><td>1928.3</td></tr> <tr><td>yellow</td><td>1928.4</td></tr> <tr><td>turquoise</td><td>1928.5</td></tr> </table>	grey	1928.1	blue	1928.2	violet red	1928.3	yellow	1928.4	turquoise	1928.5	
grey	1928.1												
blue	1928.2												
violet red	1928.3												
yellow	1928.4												
turquoise	1928.5												
fuego computer trolley 3	<div style="border: 1px solid black; padding: 2px; display: inline-block;">new</div>		<p><b>1435 mm high, with a 75 and 100 mm VESA standard TFT screen mount, attached to a height-adjustable column, with a mouse pull-out and by 215 mm frontward extendable pull-out keyboard shelf, with an extra shelf, a multipoint socket outlet with 4 sockets and a sliding handle.</b></p> <p>Colour of decorative strips:</p> <table border="0"> <tr><td>grey</td><td>1930.1</td></tr> <tr><td>blue</td><td>1930.2</td></tr> <tr><td>violet red</td><td>1930.3</td></tr> <tr><td>yellow</td><td>1930.4</td></tr> <tr><td>turquoise</td><td>1930.5</td></tr> </table>	grey	1930.1	blue	1930.2	violet red	1930.3	yellow	1930.4	turquoise	1930.5
grey	1930.1												
blue	1930.2												
violet red	1930.3												
yellow	1930.4												
turquoise	1930.5												
fuego endoscopy cart		<p><b>1347 mm high (height of profile 950 mm), with 3 trays, socket board with 4 sockets, universal holder for endoscopy on height-adjustable column (adjustment height up to ca. 800 mm), for one-hand use, and pushing handle.</b></p> <p>Colour of decorative strips:</p> <table border="0"> <tr><td>grey</td><td>1916.1</td></tr> <tr><td>blue</td><td>1916.2</td></tr> <tr><td>violet red</td><td>1916.3</td></tr> <tr><td>yellow</td><td>1916.4</td></tr> <tr><td>turquoise</td><td>1916.5</td></tr> </table>	grey	1916.1	blue	1916.2	violet red	1916.3	yellow	1916.4	turquoise	1916.5	
grey	1916.1												
blue	1916.2												
violet red	1916.3												
yellow	1916.4												
turquoise	1916.5												

Item	Description	Ref no	
<b>fuego ergometry cart 1</b> prepared for taking up the suction unit Strässle DT 100		<b>height of the cart without suction unit 1048 mm (height of profile 800 mm), with 2 trays, socket board with 4 sockets and pushing handle.</b> The cart is prepared to take up the suction unit, but <b>delivery is WITHOUT suction unit.</b>	
		Colour of decorative strips:	
		grey	<b>1917.1</b>
		blue	<b>1917.2</b>
		violet red	<b>1917.3</b>
		yellow	<b>1917.4</b>
turquoise	<b>1917.5</b>		

<b>fuego ergometry cart 2</b> prepared for taking up the suction unit KISS		<b>height of the cart without suction unit 977 mm (height of profile 800 mm), with 2 trays, socket board with 4 sockets and pushing handle.</b> The cart is prepared to take up the suction unit, but <b>delivery is WITHOUT suction unit.</b> The supporting tube of the KISS suction unit has to be adapted at our factory. Please send us the supporting tube of the suction unit together with your order.	
		Colour of decorative strips:	
		grey	<b>1918.1</b>
		blue	<b>1918.2</b>
		violet red	<b>1918.3</b>
		yellow	<b>1918.4</b>
turquoise	<b>1918.5</b>		

<b>fuego ergometry-cart</b>		<b>1650 mm high (high of profile 950 mm), with 2 trays, socket board with 4 sockets and pushing handle, 1 wire basket, cable and hose holder</b>	
		Colour of decorative strips:	
		grey	<b>1919.1</b>
		blue	<b>1919.2</b>
		violet red	<b>1919.3</b>
		yellow	<b>1919.4</b>
turquoise	<b>1919.5</b>		

## System parts

The reference numbers of the system parts include the complete range of attachment fittings.

<b>Castors</b> Surcharge	for 4 electrically conductive castors, 2 with Ø 65 mm (lockable), 2 castors with Ø 125 mm.
	Ref. no. <b>19023</b>

<b>Console shelf</b>	medium-density fibreboard (MDF) with particularly fine surface, painted grey, load capacity approx. 15 kg, mechanical height adjustment, adjustment height up to 300 mm.
----------------------	--



**Dim.: 431 x 330 x 15 mm (w x d x h)**

Ref. no. **19088**

<b>Tray</b>	steel, powder-coated, RAL 9006
	<b>Dim.: 495 x 379 x 4 mm (w x d x h)</b>
	Ref. no. <b>19330</b>

**NEU**

<b>Tray</b>	ABS plastic
	<b>Dim.: 464 x 340 mm (w x d), Exterior dim.: 501 x 386 x 54,8 mm (w x d x h), max. load capacity ca. 15 kg.</b>
	Ref. no. <b>19033</b>

### Desk shelf



from stable hard-wearing laminate wood, birch, grey stain, with roll protection, fixed tilt 20°, load capacity approx. 15 kg, mechanical height adjustment, adjustment height up to 300 mm.

**Dim.: 495 x 542 x 18 mm (w x d x h)**

Ref. no. **19087**

### Distance terminal



fitting piece between shelf and column for more depth (3,8 cm)

Ref. no. **19312**

### Tray for notebook

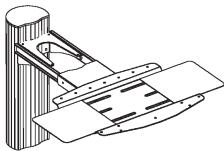

extendable frontwards, attached to a height adjustable column, mouse pull-out extendable at each side; RAL 9006 white aluminium powder coated steel.

**Setting dim shelf: 360 x 295 mm (w x d)**

**mouse pull-out each: 179 x 171 mm (w x d)**

Ref. no. **19319**

### PC support

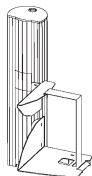

for fastening sideways to the fuego profile; RAL 9006 white aluminium powder coated steel. The flexible fixing strap ensures a firm hold of the processor. It is suitable for all conventional models, as the top mount is vertically adjustable.

**right**  
Ref. no. **19230**

**left**  
Ref. no. **19245**

### Socket board



4 grounding sockets in accordance with DIN 49440, 16A-250 VAC, light-grey cable HO5VVF, 3G 1.5 mm<sup>2</sup>, 3 m in length with moulded grounding plug, green 2-pin switch, quality housing anodised aluminium, incl. 2 grey plastic fastening angles.

**Dim.: 44,5 x 44,5 x 264 mm (w x d x h). The multiple socket board corresponds to EN 60 601-1 and all other relevant DIN, EN and IEC standards.**

Ref. no. **19029**

### Rail for storage shelf



made from steel tube, high-grade powder-coated RAL 9006 (white aluminium), Ø 6 mm, surrounds shelf on three sides, as additional stop for equipment, fixed on profile.

Ref. no. **19017**

### Tray for notebook

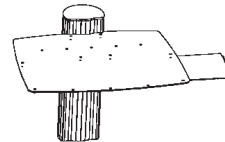

with mousepad, extendable to the right or left side; RAL 9006 white aluminium powder coated steel

**Setting dim. shelf: 491 x 370 mm (w x d)**

**mouse pull-out dim.: 100 x 171 mm (w x d)**

Ref. no. **19320**

### TFT mount with keyboard shelf and mouse pad



mount for TFT monitor with VESA standard 75 and 100, on height-adjustable column made from nickel-chromium steel, max. adjustable height 300 mm, and solid keyboard arm with mouse pullout. The keyboard arm and mouse pullout are supplied with a comfortably padded wrist support in black.

Ref. no. **19222**

### TFT-mount



mount for TFT monitor at a height-adjustable, 75 and 100 mm VESA standard column; RAL 9006 white aluminium powder coated steel

Ref. no. **19223**

### keyboard and mouse pull-out shelf



keyboard pull-out shelf extendable frontward by 215 mm; mouse pull-out extendable sideways by 100 mm at each side; RAL 9006 white aluminium powder coated steel.

Ref. no. **19220**

### Holder for Kensington-Lock



attached to the profile, for protection of notebooks. Without the lock.

Ref. no. **16424**

Isolation transformers in different executions on special request.

## Accessories

All accessories can be easily fitted to the carts. The reference numbers contain the accessory part complete with attachment fittings. The price includes assembly.

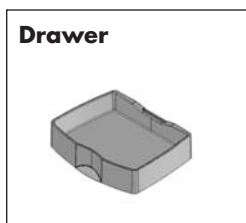

**Drawer**

ABS oriongrey with polished surface to be mounted under a tray.

**Dim.:**  
**494 x 386 x 131 mm (w x d x h)**

Ref. no. **19300**

**new**



**Handle**

to be mounted at the front side of a tray, white-aluminium, RAL 9006

Ref. no. **19367**

**new**

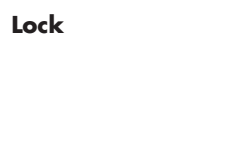

**Lock**

for the fuego drawer

Ref. no. **19376**

**new**

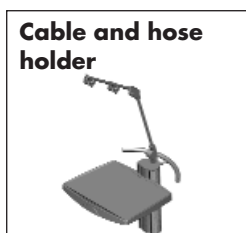

**Cable and hose holder**

grey, reach approx. 950 mm

Ref. no. **19034**



**Infusion bottle holder**

chrome plated with 4 hooks, Ø 25 mm, for one-hand use

Ref. no. **19035**



**Wire basket**

**to be mounted at the front side of the profile**, steel, powder-coated RAL 9006 (white aluminium)

**Dim.:**  
**418 x 268 x 100 mm (w x d x h)**

Ref. no. **19135**



**Wire basket extendable**

extendable for the front (215 mm), powder-coated RAL 9006 (white aluminium)

**Dim.:**  
**418 x 268 x 100 mm (w x d x h)**

Ref. no. **19268**

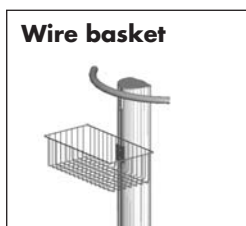

**Wire basket**

**to be mounted at the rear side of the profile**, steel, powder-coated RAL 9006 (white aluminium)

**Dim.:**  
**377 x 196 x 115 mm (w x d x h)**

Ref. no. **19146**

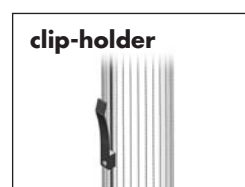

**clip-holder**

for mains cable

Ref. no. **19015**



**Planning sketch fuego 997 mm high**

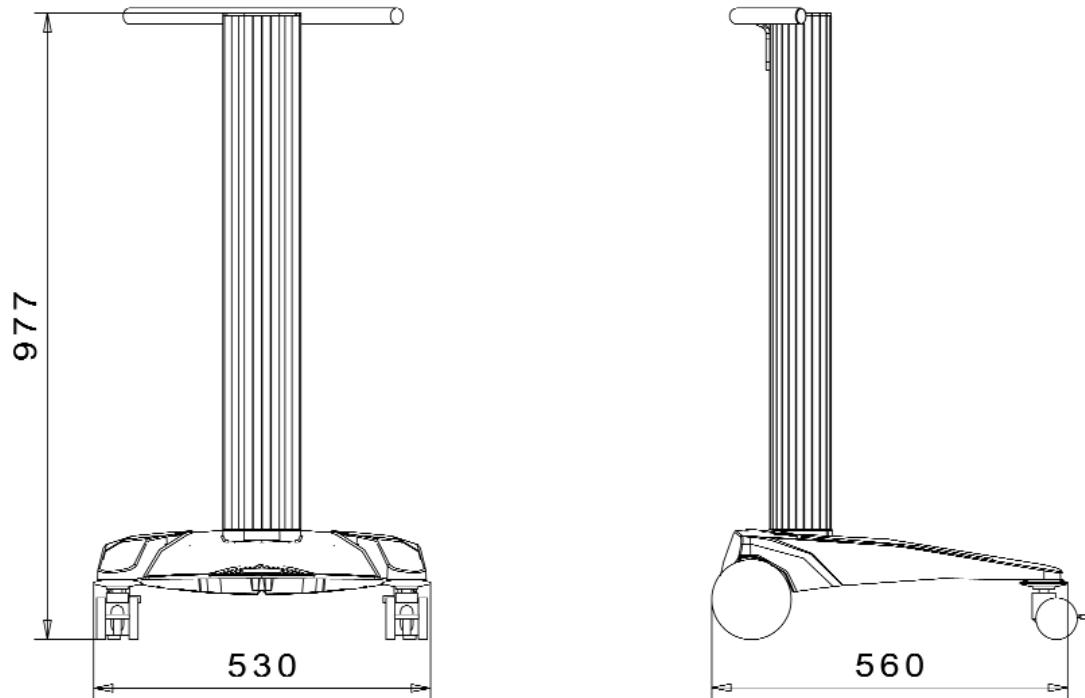

**Planning sketch fuego 1127 mm high**

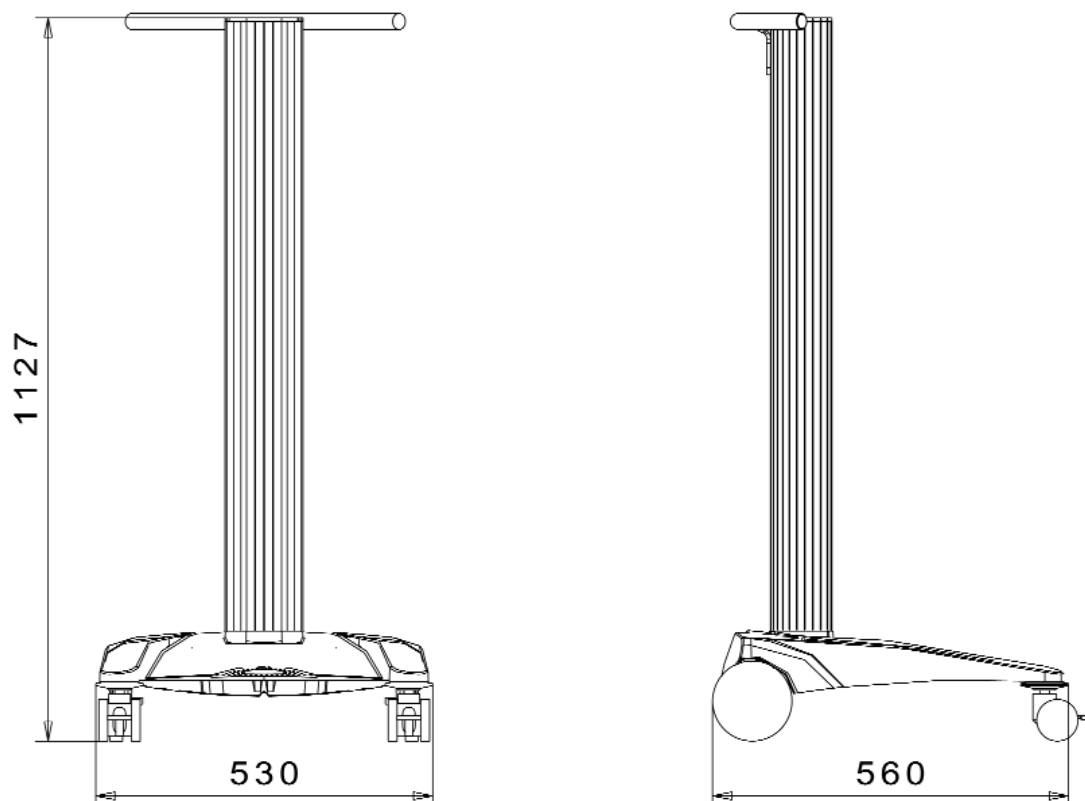



**HAEBERLE GmbH + Co. KG**  
Breitwiesenstraße 13 · D-70565 Stuttgart  
P.O.Box 800524 · D-70505 Stuttgart  
Phone ++49 (0) 7 11/7 83 14-0  
Fax ++49 (0) 7 11/7 83 14-77  
e-mail: [info@haeberle-med.de](mailto:info@haeberle-med.de)  
[www.haeberle-med.de](http://www.haeberle-med.de)

Your medical distributor