

# HAEBERLE

multifunctional medical  
cart systems ...and more

## Round trolleys

Hospicar<sup>®</sup>  
and swingo<sup>®</sup>-visit

# type list

valid up from 1 July 2007



## HAEBERLE Hospicar®

### The individual functiontrolley system

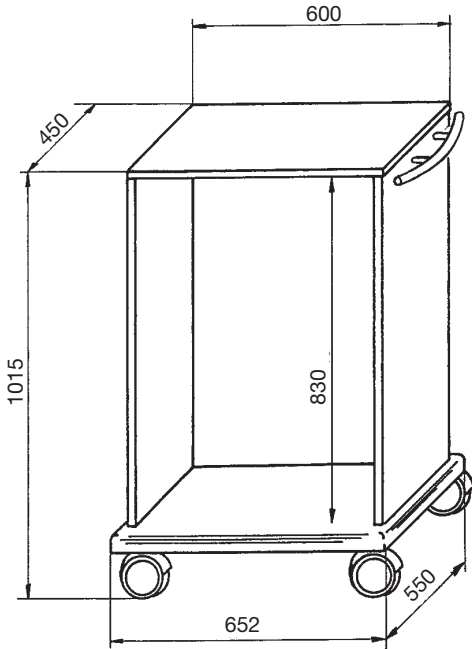

for daily work in clinics, old peoples and nursing homes, sanatoriums... - on all spots where patient data has to be ready at hand.

Hospicar® stands for variability, functionality and long-lastingness life. The ideal trolley for many requirements!

Now this successful series has been improved.

#### The features:

- **case and shelves:** wood-plastic combination, high quality laminated, with all round edges, 22 mm thick, non fading and containing no formaldehyde, in white.
- **drawers** in wood-plastic combination, high-quality laminated, non fading and free of formaldehyde, easy-glide bearing telescopic action with engaging mechanism
- generally closed, **easy-clean** surfaces

- 100 mm Ø plastic tandem **castors**, 2 of them lockable
- **load carrying capacity:** drawer surface load up to 15 kg, tray surface load up to 30 kg; maximum overall load taking into account the aspect of tilt safety, up to 150 kg.
- **dimensions:** width 710 mm (incl. push handle), depth 550 mm, height 1015 mm (ideal for writing)

#### Your advantage:

**We realize special design and special colours on request. Please contact the export department!**

### Hospicar planning screen

Please copy for your order

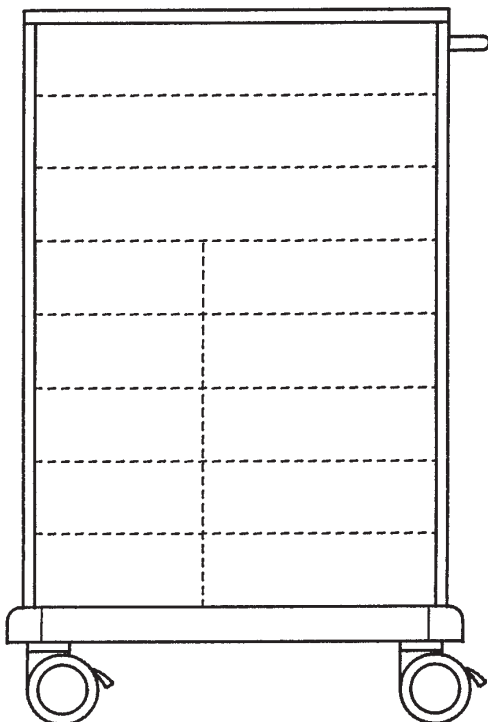

#### Data:

#### Basic model

ref.no. \_\_\_\_\_

quantity \_\_\_\_\_

#### System parts

drawers, ref.no. \_\_\_\_\_

\_\_\_\_\_

\_\_\_\_\_

\_\_\_\_\_

\_\_\_\_\_

\_\_\_\_\_

\_\_\_\_\_

\_\_\_\_\_

\_\_\_\_\_

\_\_\_\_\_

\_\_\_\_\_

\_\_\_\_\_

\_\_\_\_\_

\_\_\_\_\_

filing drawers

ref.no. \_\_\_\_\_

\_\_\_\_\_

\_\_\_\_\_

\_\_\_\_\_

\_\_\_\_\_

shelves and vertical shelves, ref.no.

\_\_\_\_\_

\_\_\_\_\_

\_\_\_\_\_

\_\_\_\_\_

\_\_\_\_\_

\_\_\_\_\_

\_\_\_\_\_

\_\_\_\_\_

\_\_\_\_\_

\_\_\_\_\_

\_\_\_\_\_

\_\_\_\_\_

#### Accessories, ref.no.

\_\_\_\_\_

\_\_\_\_\_

\_\_\_\_\_

# HAEBERLE SWINGO-visit

## The superlative round trolley

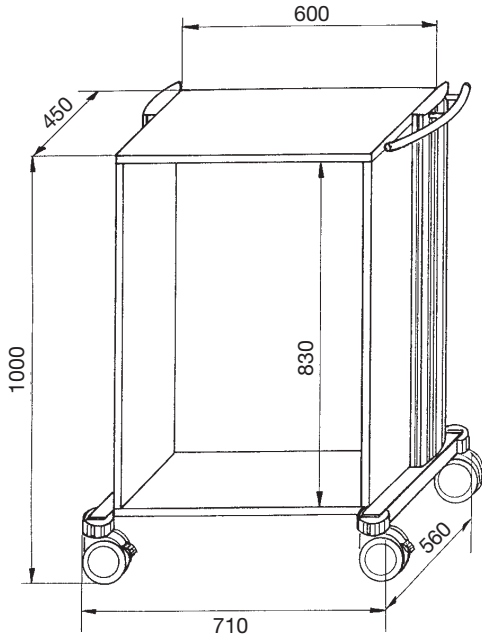

Surely you already know the new cart system swingo®.

swingo-visit has been developed on the basis of the swingo system and offers individual solutions for many requirements as well as exclusive design and high lighting colours. Just create your own individual trolley, choosing from many system parts and accessories!

If you want more information about swingo, please ask for brochures.

### The features:

- sturdy **aluminium construction** with various possibilities to fix system parts and accessories; integrated cable duct; coloured push handle as standard
- **case and shelves** wood-plastic combination, high quality laminated, with all round edges, 22 mm thick, non fading and containing no formaldehyde, white.
- **drawers:** Wood-plastic combination, high quality laminated, non-fade and containing no formaldehyde, easy-glide bearing telescopic action with engaging mechanism.

- closed, easy-clean surfaces
- **castors:** plastic tandem castors , Ø 100 mm, 2 lockable
- **colours:** Handles and decorative strips in 5 modern, highlight colours according to the latest NCS design scale: grey, blue, turquoise, yellow, violet red.
- **load carrying capacity:** drawer surface load up to 15 kg, tray surface load up to 30 kg, maximum overall load taking into account the aspect of tilt safety, up to 150 kg.
- **dimensions:** width 750 mm (incl. push handle), depth 560 mm; height 1000 mm.

### Your advantage:

**We realize special design and special colours on request. Please contact the export department!**

## swingo-visit planning screen

Please copy for your order

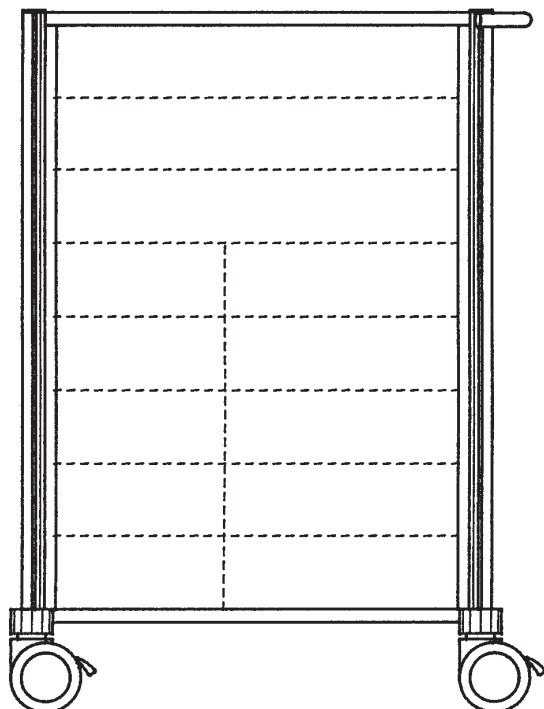

### Data:

#### Basic model

ref.no \_\_\_\_\_  
 quantity \_\_\_\_\_

#### System parts

drawers, ref.no. \_\_\_\_\_  
 \_\_\_\_\_  
 \_\_\_\_\_  
 \_\_\_\_\_

drawers inset  
 ref.no. \_\_\_\_\_  
 \_\_\_\_\_  
 \_\_\_\_\_

filing drawers  
 ref.no. \_\_\_\_\_  
 \_\_\_\_\_  
 \_\_\_\_\_

shelves and vertical shelves, ref.no. \_\_\_\_\_  
 \_\_\_\_\_  
 \_\_\_\_\_

diverse, ref.no. \_\_\_\_\_  
 \_\_\_\_\_  
 \_\_\_\_\_

**Accessories**, ref.no. \_\_\_\_\_  
 \_\_\_\_\_  
 \_\_\_\_\_

Item	Description	Ref. no.
------	-------------	----------

## Special models

The Hospicar® range is a system with unlimited freedom of combination. Even orders for only a few trolleys can be supplied with all design versions and ultimate individual sizes. The customer can choose from a variety of materials and finishes. Please contact the HAEBERLE team.

### Hospicar® patient care trolley

**NEW**

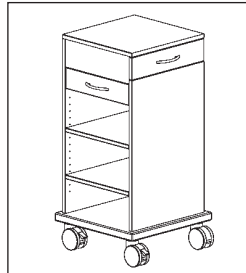

Basic trolley of special size with side push handle, pull-out laptop computer shelf at the side, holder for Kensington lock, 1 drawer and 2 shelves. Castors Ø 100 mm, 2 are lockable.

**Dim.: 518 x 503 x 1018 mm (w x d x h)**

white

**16423**

### Hospicar® doctor's trolley

**NEW**

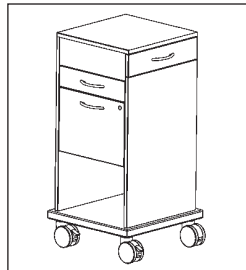

Basic trolley of special size with side push handle, pull-out laptop computer drawer at the side, holder for Kensington lock, 1 drawer, 10 cm high, 1 DIN A4 filing drawer. Castors Ø 100 mm, 2 are lockable.

**Dim.: 518 x 503 x 1018 mm (w x d x h)**

white

**16422**

## Hospicar® basic model

### Hospicar® basic model

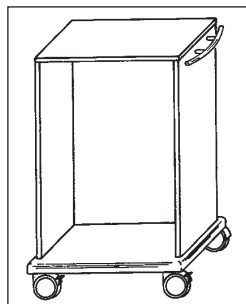

White plastic veneered body, white push handle and sturdy edge protection all around. Castors Ø 100 mm, 2 lockable.

**Dim.: 710 x 550 x 1015 mm (w x d x h)**

white

**06506**

Other colour combinations of push handles and decorative stripes (page 9)

## Hospicar® function trolleys

The models listed here are only a limited selection of the available range. Individual systems can be configured at any time. Please refer to the planning schematic on page 2.

**Please notice:** all Hospicar-trolleys - including the below listed models - are individually manufactured for you. Therefore cancelling or changement of the order is only possible up to 3 days after the receipt of the order confirmation!

### Hospicar® round trolley 1

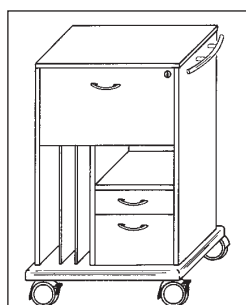

Filing drawer DIN A4, shelf below, inset for X-ray folders with vertical subdivision. Partition wall for shelf, below one small shelf and two small drawers 100 and 200 mm high.

white

**06482**

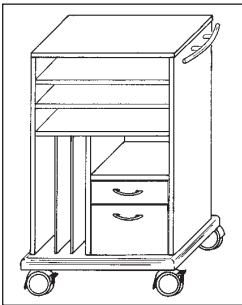
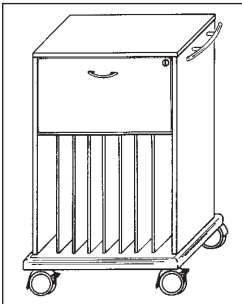
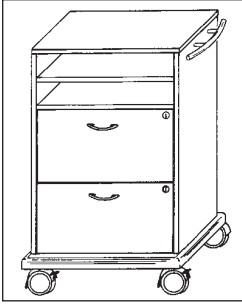
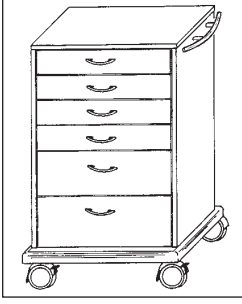
Item	Description	Ref. no.	
<b>Hospicar® round trolley 2</b>		3 shelves, 1 small shelf, 1 small drawer 100 mm high, 1 small drawer 200 mm high, 3 insets for X-ray-folders with vertical subdivi- on	<b>14177</b>
<b>Hospicar® round trolley 3</b>		1 filing drawer DIN A4, below inset for X-ray folders with vertical subdivision	<b>14178</b>
<b>Hospicar® round trolley 5</b>		2 shelves, 2 filing drawers DIN A 4, with inte- grated weight against inclination of the trolley, when the drawers are pulled out.	<b>14180</b>
<b>Hospicar® medicine trolley</b>		4 drawers 100 mm, 2 drawers 200 mm	<b>14181</b>

## swingo®-visit basic model

### swingo®-visit basic model

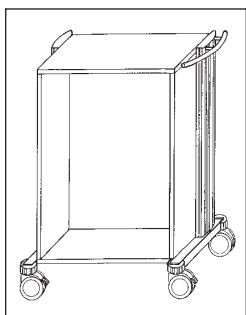

White body with aluminium carrier unit and  
coloured strips and handle.  
Castors. Ø 100 mm, 2 lockable.

**Dim.: 750 x 560 x 1000 mm (w x d x h)**

**Colour of handle and decorative strips:**

grey	<b>13541</b>
blue	<b>13542</b>
violet red	<b>13543</b>
yellow	<b>13544</b>
turquoise	<b>13545</b>

Item	Description	Ref. no.
------	-------------	----------

## swingo®-visit function trolleys

The models listed here are only a limited selection of the available range. Individual systems can be configured at any time. Please refer to the planning schematic on page 3.  
**Please notice: all swingo®-visit-trolleys - including the below listed models - are individually manufactured for you. Therefore cancelling or changement of the order is only possible up to 3 days after the receipt of the order confirmation!**

### swingo®-visit round trolley 1

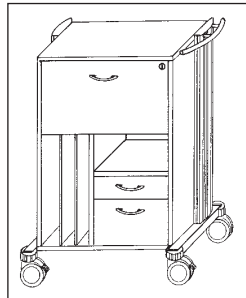

Filing drawer DIN A4, shelf, below inset for X-ray folders with vertical subdivision. Partition wall for shelf, below small shelf and two small drawers 100 and 200 mm high, 1 push handle.

#### Colour of handles and decorative strips:

grey	<b>13551</b>
blue	<b>13552</b>
violet red	<b>13553</b>
yellow	<b>13554</b>
turquoise	<b>13555</b>

### swingo®-visit round trolley 2

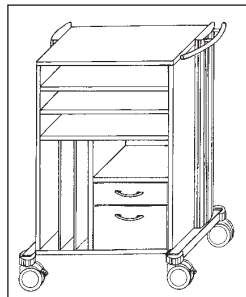

3 shelves, 1 small shelf, 1 small drawer 100 mm high, 1 small drawer 200 mm high, inset for X-ray-folders with vertical subdivision, 1 push handle

#### Colour of handles and decorative strips:

grey	<b>13561</b>
blue	<b>13562</b>
violet red	<b>13563</b>
yellow	<b>13564</b>
turquoise	<b>13565</b>

### swingo®-visit round trolley 3

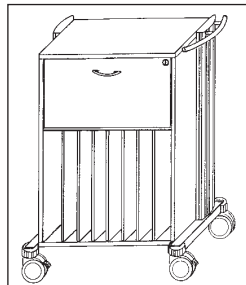

1 filing drawer DIN A4, below inset for X-ray folders with vertical subdivision, 1 push handle

#### Colour of handles and decorative strips:

grey	<b>13531</b>
blue	<b>13532</b>
violet red	<b>13533</b>
yellow	<b>13534</b>
turquoise	<b>13535</b>

### swingo®-visit round trolley 4

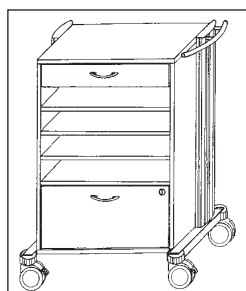

1 drawer 100 mm, 4 shelves, 1 filing drawer DIN A4, 1 push handle

#### Colour of handles and decorative strips:

grey	<b>13571</b>
blue	<b>13572</b>
violet red	<b>13573</b>
yellow	<b>13574</b>
turquoise	<b>13575</b>

### swingo®-visit round trolley 5

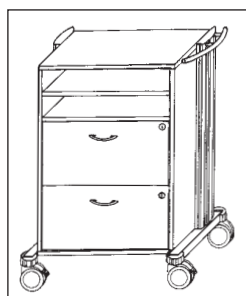

shelves 2 filing drawers DIN A4 with integrated weight against inclination of the trolley, when the drawers are pulled out.

#### Colour of handles and decorative strips:

grey	<b>13581</b>
blue	<b>13582</b>
violet red	<b>13583</b>
yellow	<b>13584</b>
turquoise	<b>13585</b>



Item	Description	Ref. no.
------	-------------	----------

## functional trolleys swingo®-visit

swingo®-visit  
medicine trolley

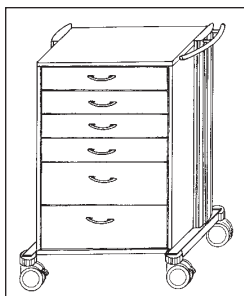

4 drawers 100 mm, 2 drawers 200 mm, 1 push handle

**Colour of handles and decorative strips:**

grey	<b>13591</b>
blue	<b>13592</b>
violet red	<b>13593</b>
yellow	<b>13594</b>
turquoise	<b>13595</b>

## Hospicar® and swingo®-visit system parts

All system parts can be individually combined within the scope of the screen. When ordering, please indicate the required system parts and their exact position. By means of the schematic on pages 2 and 3 it is very easy. Each basic model has 8 screen lines. The respective height of each system part is indicated. All system parts are white unless otherwise indicated. The assembly will be effected by HAEBERLE.

### Drawers and drawer inserts

**Drawer**

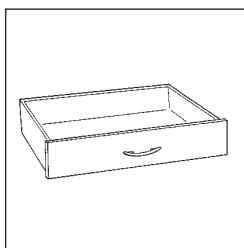

100 mm high = 1 screen line

**Colour of handles:**

white	<b>06509</b>
grey	<b>13231</b>
blue	<b>13232</b>
violet red	<b>13233</b>
yellow	<b>13234</b>
turquoise	<b>13235</b>

dto. but lockable

**Colour of handles:**

white	<b>10354</b>
grey	<b>13241</b>
blue	<b>13242</b>
violet red	<b>13243</b>
yellow	<b>13244</b>
turquoise	<b>13245</b>

**Drawer**

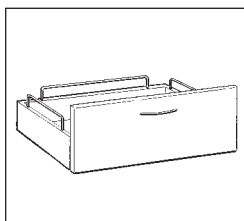

200 mm high = 2 screen lines

**Colour of handles:**

grey	<b>06512</b>
blue	<b>13291</b>
violet red	<b>13292</b>
yellow	<b>13293</b>
turquoise	<b>13294</b>
	<b>13295</b>

dto. but lockable

**Colour of handles:**

white	<b>10355</b>
grey	<b>13251</b>
blue	<b>13252</b>
violet red	<b>13253</b>
yellow	<b>13254</b>
turquoise	<b>13255</b>

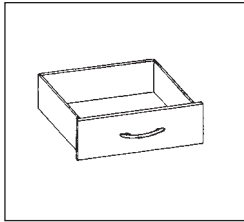
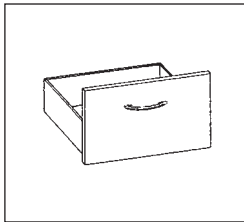
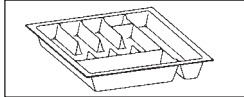
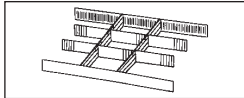
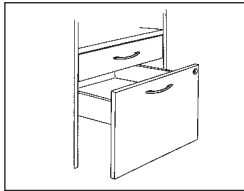
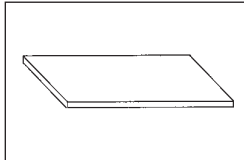
Item	Description	Ref. no.	
Drawer		small 100 mm high = 1 screen line <b>Dim.: 330 x 370 x 100 mm (w x d x h)</b>  <b>colour of handles:</b> white grey blue violet red yellow turquoise	<b>06515</b> <b>13261</b> <b>13262</b> <b>13263</b> <b>13264</b> <b>13265</b>
		small 200 mm high = 2 screen lines <b>Dim.: 330 x 370 x 200 mm (w x d x h)</b>  <b>colour of handles:</b> white grey blue violet red yellow turquoise	<b>06518</b> <b>13271</b> <b>13272</b> <b>13273</b> <b>13274</b> <b>13275</b>
Drawer insert		white plastic with fixed division  <b>Dim.: 529 x 384 x 58 mm (w x d x h)</b>	<b>13903</b>
Drawer insert		1 set with variable division  <b>Dim.: 529 x 384 x 58 mm (w x d x h)</b>	<b>13933</b>
<b>Filing cabinet and X-ray bag drawers</b>			
Filing cabinet drawer		DIN A4, with safe lock, 310 mm high = 3 screen lines  <b>Colour of handles:</b> white grey blue violet red yellow turquoise	<b>06525</b> <b>13281</b> <b>13282</b> <b>13283</b> <b>13284</b> <b>13285</b>
balancing weight	to prevent tilting, when equipped with two filing drawers	<b>15622</b>	
<b>Shelves and vertical shelves</b>			
Shelf		560 mm wide, bottom-side with screen perforation; also suitable for installing vertical shelves for X-ray folders  small, 330 mm wide, 20 mm thick	<b>06552</b>  <b>06548</b>
Vertical shelf for X-ray folders	up to 7 subdivisions can be selected for a given carriage width, 500 mm high, thickness of wall 10 mm = 5 screen lines	<b>06554</b>	
Vertical shelf	for installation of small drawers and shelves, can be chosen right or left, 500 mm high, thickness of wall 19 mm = 5 screen lines	<b>06556</b>	

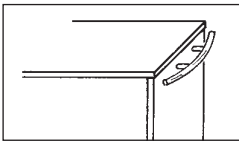
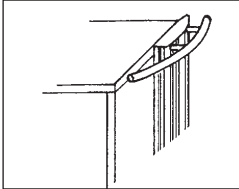
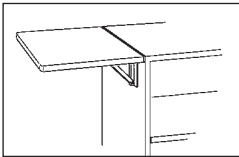
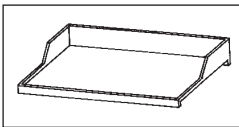
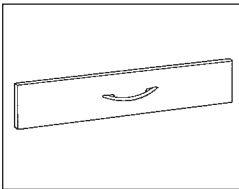
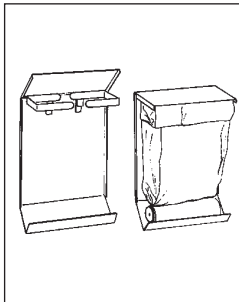

Item	Description	Ref. no.
<b>Various system parts</b>		
<b>Push handle for Hospicar®</b> 	 <p>made of metal, white, RAL 9010            grey            blue            violet red            yellow            turquoise</p>	<b>14661</b> <b>16439</b> <b>16443</b> <b>16441</b> <b>16440</b> <b>16442</b>
<b>Push handle for swingo®-visit</b>	 <p>made of lacquered metal, 50 mm deep            grey            blue            violet red            yellow            turquoise</p>	<b>13801</b> <b>13802</b> <b>13803</b> <b>13804</b> <b>13805</b>
<b>Lateral shelf for Hospicar®</b>	 <p>can be folded down  <b>Dim.: 450 x 450 x 19 mm (w x d x h)</b></p>	<b>10161</b>
<b>Gallery</b>	 <p>made of sturdy white plastic, with 3 borders</p>	<b>13951</b>
<b>Accessories for Hospicar® and swingo®-visit</b>		
<p>All accessories can be easily fitted to the trolleys. The reference numbers contain the accessory part complete with attachment fittings.</p>		
<b>Coloured drawer handles</b>	 <p>Modern designer handles. Please indicate colour on your order            grey            blue            violet red            yellow            turquoise            white            black</p>	<b>13161</b> <b>13162</b> <b>13163</b> <b>13164</b> <b>13165</b> <b>13166</b> <b>13167</b>
<b>Waste Containers and Waste Collectors</b>		
<b>Piccolo waste collector</b>	 <p>Steelsheet, aluminium colour powder coated or s/s, available with lid if required. Including 1 roll of waste bags 15 l  <b>Dim.: 280 x 160 x 410 mm (w x d x h)</b></p>	
	<b>for Hospicar,</b> aluminium colour powder coated s/s	<b>07873</b> <b>05138</b>
	<b>for swingo®-visit</b> aluminium colour powder coated s/s	<b>13908</b> <b>13909</b>
<b>Piccolo lid</b>	aluminium colour powder coated s/s <b>Dim.: 280 x 170 x 20 mm (w x d x h)</b>	<b>07874</b> <b>09636</b>
<b>Roll of disposal bags</b>	15 l with 50 bags, grey, <b>minimum order quantity 10 rolls, p. rl.</b>	<b>05191</b>

Item	Description	Ref. no.
------	-------------	----------

## Injection and Band-Aid Dispensers

If you wish to know more about our PicBox® range of dispensers please ask for our brochure on supply and waste disposal.

**PicBox® Plus injection set**

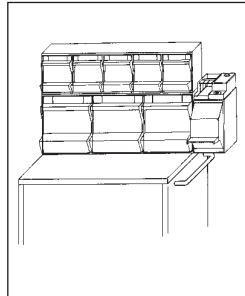

**The dispenser with the first-in/first-out guarantee in accordance with DIN 58953**

The boxes are replenished from the top, the material taken from below. This ensures that items placed in first, will also be used first (first-in/first-out principle) Grey-white plastic casing with clear glass boxes.

**Each box with extra lid against dust.**

Consisting of needle dispenser with 3 boxes and canula dispensers with 5 boxes and attached KOMBI-Set.

**Dim.: 730 x 240 x 410 mm (w x d x h) 11387**

**PicBox® injection set**

as described above but without KOMBI-Set.

**Dim.: 600 x 200 x 410 mm (w x d x h) 11382**

## Waste Disposal Boxes for Canulas etc.

The ref. numbers include the special holder attachment. All waste disposal boxes are made of non polluting plastics which can be incinerated without harmful residues to the environment.

**Medi-Müll waste disposal container**

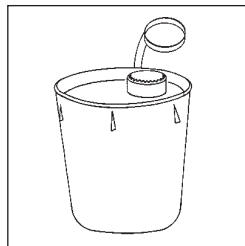

made of sunshine yellow polypropylene with HAEBERLE green lid. Offers 3 practical ways for disposing of all types of canula, including vacuum containers. Ideally suited for scalpels, pipettes, broken glass, swabs etc. 1,5 l capacity

**Dim.: Ø 140 mm, 145 mm height**

Medi-Müll set with 20 boxes and mounting,  
**for Hospicar®**  
**for swingo®-visit**

**04780**  
**13919**

**Medi-Müll original carton**

with 120 boxes, without mounting

**04668**

**Attachment**

for Medi-Müll to **Hospicar®**,  
for Medi-Müll to **swingo®-visit**

**04671**  
**13920**

**Schluckfix used canula container for swingo®-visit**

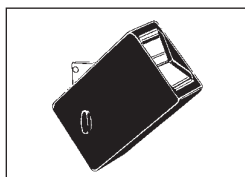

Disposable container for holding approx. 500 used canulas, made of black recycled plastic. Sliding scale price list available on request. Schluckfix set with 20 boxes and swingo®-visit mounting

**13917**

**Dim.: 55 x 100 x 170 mm (w x d x h)**

**Schluckfix original carton**

with 100 boxes, without mounting

**09490**

**Mounting**

for Schluckfix to swingo®-visit

**13918**

## Diverse

**Universal holder snap**

**bulk discount**

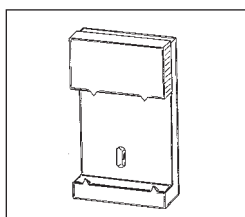

for boxes of disposable gloves, tissues or wipes. The spring-loaded clamp is adjustable to fit many box sizes. With adhesive stripes

**Dim: 100 x 20 x 165 mm (w x d x h) 15572**

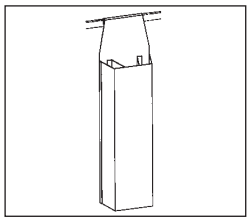
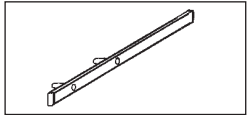
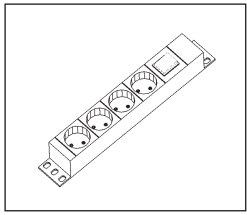
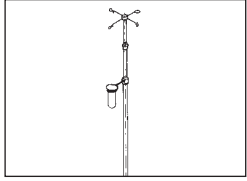
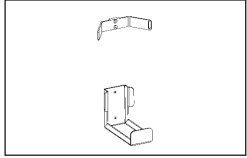
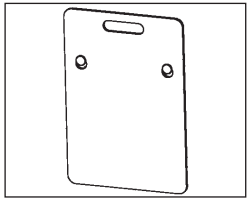
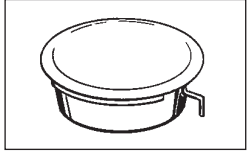
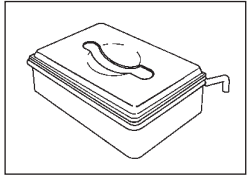
Item	Description	Ref. no.	
<b>Catheter holder</b>		<p>made of s/s, 3 compartments with spacer, for hanging at standard profile rail.  <b>Dim.: 160 x 80 x 570 mm (w x d x h)</b>  <b>for Hospicar®</b>  Please order standard profile 10291 at the same time  <b>for swingo®-visit</b>  Please order standard profile 13924 at the same time</p>	
<b>Standard profile rail</b>		<p><b>for Hospicar®</b>  <b>for swingo®-visit</b>  420 mm wide</p>	
<b>Socket board</b>	<b>NEW</b>		<p>4 grounding sockets in accordance with DIN 49440, 16A-250 VAC, light-grey cable HO5VVF, 3G 1.5 mm<sup>2</sup>, 3 m in length with moulded grounding plug, green 2-pin switch, quality housing anodised aluminium, incl. 2 grey plastic fastening angles.  <b>Dim.: 264 x 44,5 x 44,5 mm (w x d x h)</b>  <b>The multiple socket board corresponds to EN 60 601-1 and all other relevant DIN, EN and IEC standards.</b></p>
<b>Infusion bottle holder</b>		<p>chrome plated, with 4 hooks Ø 25 mm, for one-hand handling  <b>for Hospicar®</b>  <b>for swingo®-visit</b></p>	
<b>Holder</b>		<p>for oxygen bottles 5/10 l  <b>for Hospicar®</b>  <b>for swingo®-visit</b></p>	
<b>Cardiac massage board</b>		<p>made of Trespa, an especially hygienic material, totally resistant to disinfectants.  <b>Dim: 440 x 10 x 640 mm (w x d x h)</b></p>	
<b>Waste container with plastic bowl for swingo®-visit</b>		<p>300 mm Ø, grey-white plastic</p>	
<b>Instrument waste container for swingo®-visit</b>		<p>with polypropylene bowl with slit lid, can be sterilized, white  <b>Dim: 300 x 230 x 130 mm (w x d x h)</b></p>	

**Your advantage: We realize special design as from 5 units. Please contact the export department!**

# HAEBERLE



**HAEBERLE specializes in particular in providing customized OEM versions for industrial clients. Let us know your specification and we will provide you a product according to your personally requirements.**

**Please contact us!**

**HAEBERLE GmbH + Co. KG**  
Breitwiesenstraße 13 · D-70565 Stuttgart  
P.O.Box 800524 · D-70505 Stuttgart  
Phone ++49 (0) 7 11/7 83 14-0  
Fax ++49 (0) 7 11/7 83 14-77  
e-mail: [info@haeberle-med.de](mailto:info@haeberle-med.de)  
[www.haeberle-med.de](http://www.haeberle-med.de)

Your medical distributor