

**Diagnostik**  
**Diagnostic**  
**Diagnostic**  
**Diagnóstico**



**Kehlkopfspiegel  
Laryngeal Mirrors  
Miroirs laryngiens  
Espejos laríngeos**



HB 8	Fig. 000 =	6 mmØ	HB 28
HB 9	Fig. 00 =	8 mmØ	HB 29
HB 10	Fig. 0 =	10 mmØ	HB 30
HB 11	Fig. 1 =	12 mmØ	HB 31
HB 12	Fig. 2 =	14 mmØ	HB 32
HB 13	Fig. 3 =	16 mmØ	HB 33
HB 14	Fig. 4 =	18 mmØ	HB 34
HB 15	Fig. 5 =	20 mmØ	HB 35
HB 16	Fig. 6 =	22 mmØ	HB 36
HB 17	Fig. 7 =	24 mmØ	HB 37
HB 18	Fig. 8 =	26 mmØ	HB 38
HB 19	Fig. 9 =	28 mmØ	HB 39
HB 20	Fig. 10 =	30 mmØ	HB 40

**HB 25**  
10,0 cm/4"  
Metallgriff für Kehlkopfspiegel  
Metal handle for laryngeal mirrors  
Manche pour miroirs laryngiens  
Mango metálico para espejos laríngeos

**Perkussionshämmer  
Percussion Hammers  
Marteaux - percuteurs  
Martillos de percusión**



**Babinsky**

HB 45  
22 cm/8<sup>3</sup>/<sub>4</sub>"

**Babinsky**

HB 45-01  
Gummi allein  
Rubber only  
Gomme seul  
Goma suelta



**Taylor**

HB 46  
20 cm/8"



**Berliner**

HB 47  
20 cm/8"

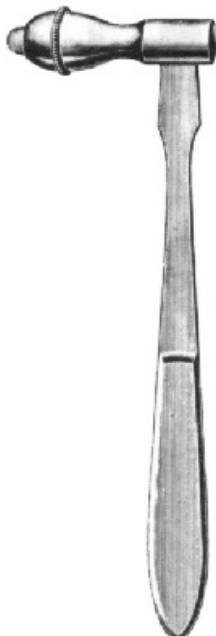

**Traube**

HB 48  
17 cm/6<sup>3</sup>/<sub>4</sub>"



**Troemner**

HB 49  
24 cm/9<sup>1</sup>/<sub>2</sub>"

**Perkussionshämmer  
Percussion Hammers  
Marteaux - percuteurs  
Martillos de percusión**



**Buck**  
HB 50  
18 cm/7"



**Déjerine**  
HB 51  
20 cm/8"



**Déjerine**  
HB 52  
21 cm/8¼"

ohne Nadel  
without needle  
sans aiguille  
sin aguja

mit Nadel  
with needle  
avec aiguille  
con aguja



**Rabiner**  
HB 53  
23 cm/9"

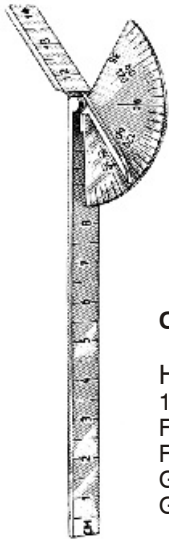

**Carroll**

HB 56  
 14,0 cm/5½"  
 Finger-Goniometer  
 Finger-Goniometer  
 Goniomètre  
 Goniómetro

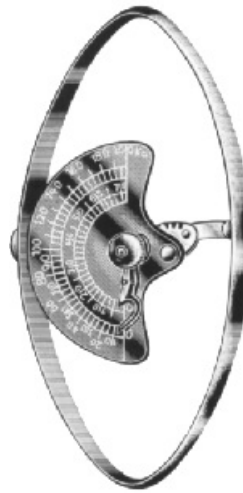

**Collin**

HB 57  
 12,5 cm/5"  
 Dynamometer, für Kinder  
 Dynamometer, for children  
 Dynamomètre, pour enfants  
 Dinamómetro, para niños

HB 58  
 12,5 cm/5"  
 Dynamometer, für Erwachsene  
 Dynamometer, for adults  
 Dynamomètre, pour adultes  
 Dinamómetro, para adultos



**Moeltgen**

HB 59  
 24,0 cm/9½"  
 Winkelmesser für die Gliedmaßen  
 Goniometer (Flexometer) for extremities  
 Goniomètre pour les membres  
 Goniómetro para miembros



**Wartenberg**

HB 60  
 19,0 cm/7½"  
 Nervrädchen  
 Neurological Pinwheel  
 Roue neurologique  
 Instrumento para examen neurológico

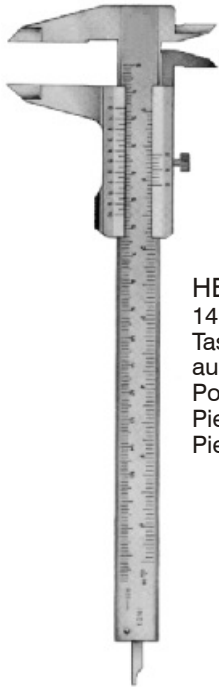

**HB 61**  
 14,0 cm/5½"  
 Taschen-Meßschieber  
 aus nichtrostendem Stahl  
 Pocket Slide Caliper, of stainless steel  
 Pied à coulisse de poche, en acier inoxydable  
 Pie de rey de bolsillo, de acero inoxidable

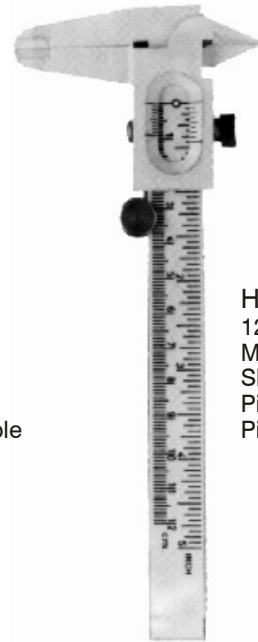

**HB 62**  
 12,0 cm/5"  
 Meßschieber aus Kunststoff  
 Slide Caliper of synthetic material  
 Pied à coulisse, en matière synthétique  
 Pie de rey, en materia sintética



**HB 64**  
 1,5 m  
 Bandmaß in Metallkapsel  
 aus Wachstuch/Leinen  
 Tape Measure in metal case  
 of oil cloth  
 Metre à ruban dans une boîte de métal  
 en toile cirée  
 Cinta métrica en cápsula metálica  
 de tela encerada

**HB 65**  
 2,0 m  
 aus Stahl  
 of steel  
 en acier  
 de acero



**Metall-Meßstab mit Millimetereinteilung**  
 Metal Rule graduated in millimeters and inches  
 Règle en métal divisé en centimètres et pouces  
 Regla métrica de metal graduada en milímetros y pulgadas

**HB 66** 15,0 cm/6"  
**HB 67** 20,0 cm/8"  
**HB 68** 30,0 cm/12"  
**HB 69** 50,0 cm/20"



**HB 70** 15,0 cm/6"

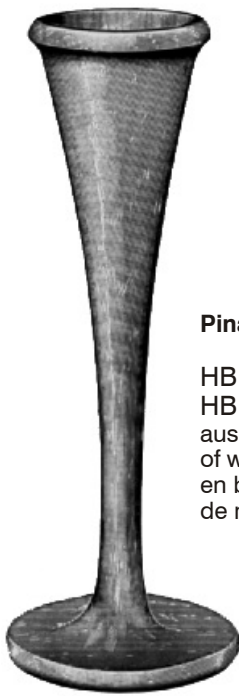

**Pinard**

HB 71 30,0 cm/12"  
HB 72 18,0 cm/7"  
aus Holz  
of wood  
en bois  
de madera



**Pinard**

HB 73 15,0 cm/6"  
aus Aluminium  
of aluminium  
en aluminium  
de aluminio

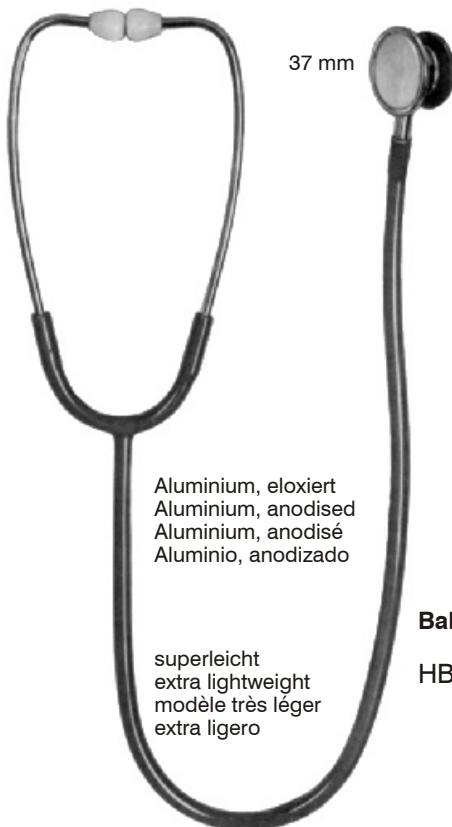

37 mm

Aluminium, eloxiert  
Aluminium, anodised  
Aluminium, anodisé  
Aluminio, anodizado

superleicht  
extra lightweight  
modèle très léger  
extra ligero

**Baby-Duplex**

HB 75

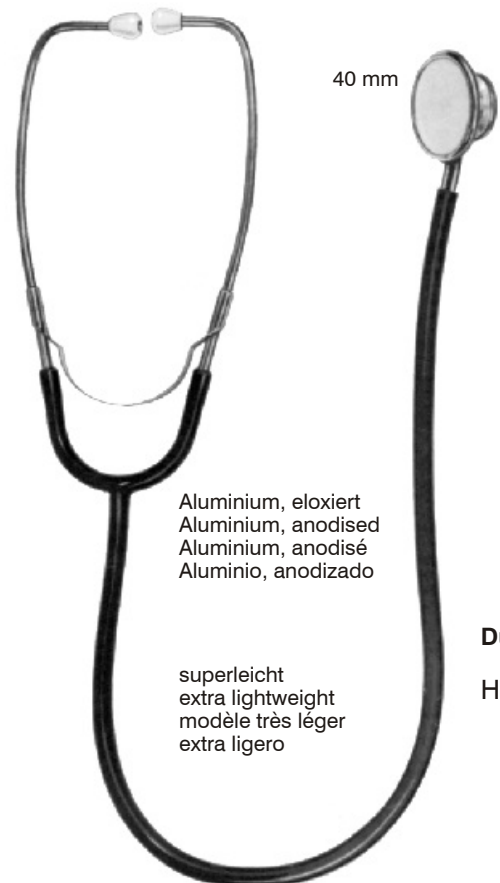

40 mm

Aluminium, eloxiert  
Aluminium, anodised  
Aluminium, anodisé  
Aluminio, anodizado

superleicht  
extra lightweight  
modèle très léger  
extra ligero

**Duplex**

HB 76



47 mm

**Anestophon**  
HB 77



**Rirap**

HB 78

Drei verschiedene austauschbare Trichteransätze  
Three additional interchangeable bell-type pieces  
Trois pièces supplémentaires interchangeables  
Tres diferentes piezas adicionales intercambiables  
en forma de embudo



aus rostfreiem Stahl  
stainless steel  
en acier inoxydable  
de acero inoxidable

**Cardiophon**  
HB 79





**Diplomat Presameter**

**HB 80**  
Quecksilbergerät  
Mercury apparatus  
Appareil de mercure  
Tensiómetro de mercurio

mit Hakenmanschette  
with hook cuff  
avec manchette à crochets  
con brazaletes a ganchos

**HB 81**  
mit Velcromanschette  
with velcro cuff  
avec manchette velcro  
con brazaletes velcro



**Empire**

**HB 82**  
Quecksilbergerät  
Mercury apparatus  
Appareil de mercure  
Tensiómetro de mercurio

mit Hakenmanschette  
with hook cuff  
avec manchette à crochets  
con brazaletes a ganchos

**HB 83**  
mit Velcromanschette  
with velcro cuff  
avec manchette velcro  
con brazaletes velcro



**Precisa**

**HB 84**  
Einhandmodel  
One hand model  
Modèle à main  
Modelo a mano

mit Velcromanschette  
with velcro cuff  
avec manchette velcro  
con brazaletes velcro

**Minimus III**

**HB 85**  
Einhandmodel  
One hand model  
Modèle à main  
Modelo a mano

mit Hakenmanschette  
with hook cuff  
avec manchette à crochets  
con brazaletes a ganchos

**HB 86**  
mit Velcromanschette  
with velcro cuff  
avec manchette velcro  
con brazaletes velcro



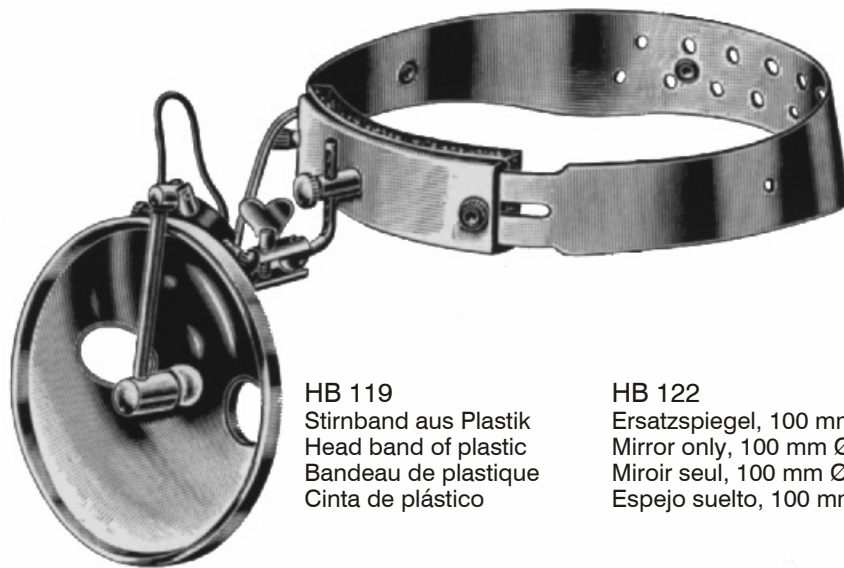

**HB 119**  
 Stirnband aus Plastik  
 Head band of plastic  
 Bandeau de plastique  
 Cinta de plástico

**HB 122**  
 Ersatzspiegel, 100 mm Ø  
 Mirror only, 100 mm Ø  
 Miroir seul, 100 mm Ø  
 Espejo suelto, 100 mm Ø

**Clar**  
 Stirnlampe  
 Head Lamp  
 Eclaireur frontal  
 Lámpara frontal

**HB 118**  
 mit Stirnband aus Plastik, 100 mm Ø  
 with head band of plastic, 100 mm Ø  
 avec bandeau de plastique, 100 mm de Ø  
 con cinta de plástico, 100 mm de Ø

**HB 120**  
 mit Stirnband aus Celluloid, 100 mm Ø  
 with head band of celluloid, 100 mm Ø  
 avec bandeau de celluloid, 100 mm de Ø  
 con cinta de celuloide, 100 mm de Ø

**HB 121**  
 Stirnband aus Celluloid  
 Head band of celluloid  
 Bandeau de celluloid  
 Cinta de celuloide

**HB 123**  
 Ersatz-Birnchen, 6 V  
 Spare bulb, 6 V  
 Lampe de rechange, 6 V  
 Bombillas de repuesto, 6 V

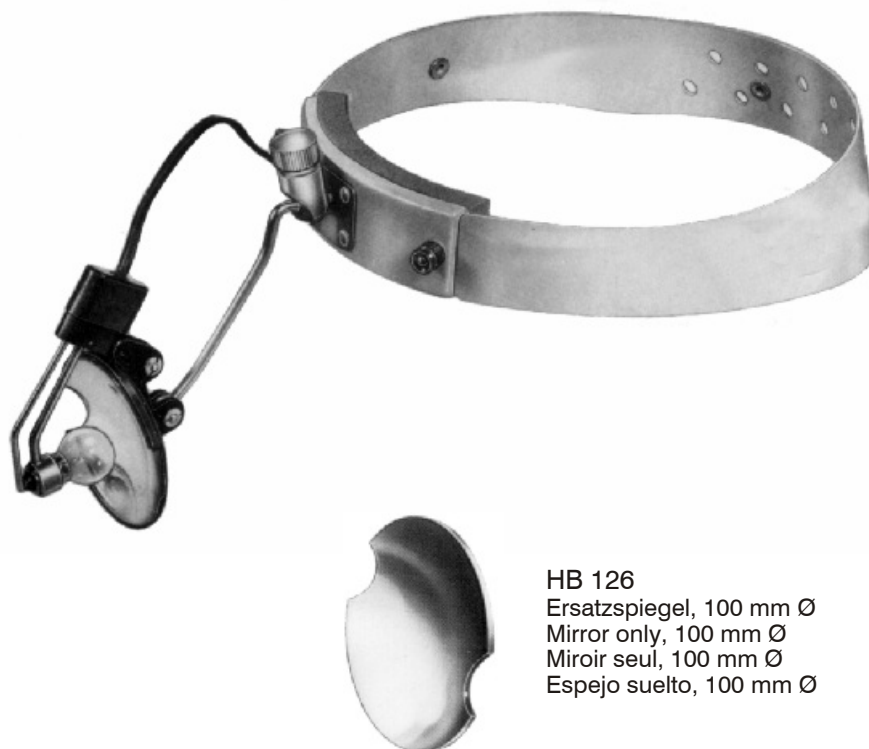

**Clar**  
 Stirnlampe  
 Head Lamp  
 Eclaireur frontal  
 Lámpara frontal

**HB 124**  
 mit Stirnband aus Celluloid  
 with head band of celluloid  
 avec bandeau de celluloid  
 con cinta de celuloide

**HB 125**  
 Stirnband aus Celluloid  
 Head band of celluloid  
 Bandeau de celluloid  
 Cinta de celuloide

**HB 126**  
 Ersatzspiegel, 100 mm Ø  
 Mirror only, 100 mm Ø  
 Miroir seul, 100 mm Ø  
 Espejo suelto, 100 mm Ø



**HB 127**  
 Ersatz-Birnchen, 6 V  
 Spare bulb, 6 V  
 Lampe de rechange, 6 V  
 Bombillas de repuesto, 6 V

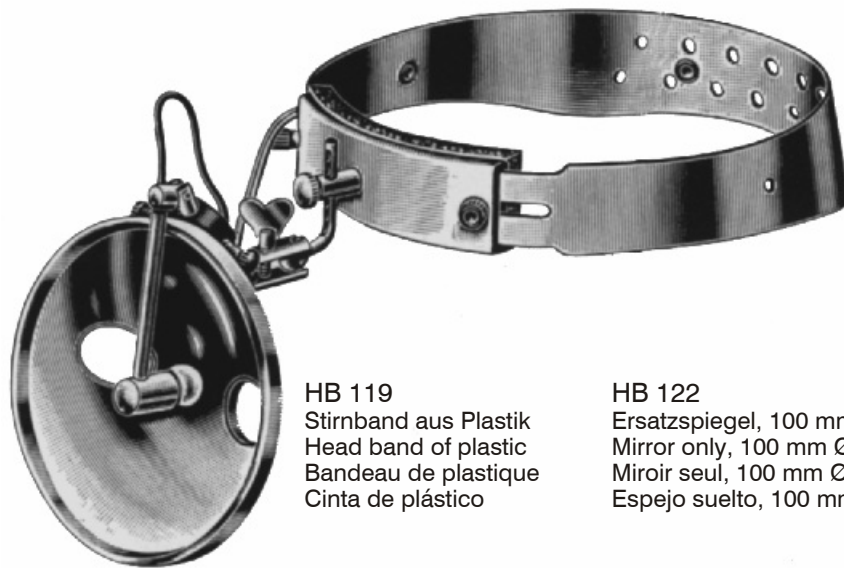

**HB 119**  
 Stirnband aus Plastik  
 Head band of plastic  
 Bandeau de plastique  
 Cinta de plástico

**HB 122**  
 Ersatzspiegel, 100 mm Ø  
 Mirror only, 100 mm Ø  
 Miroir seul, 100 mm Ø  
 Espejo suelto, 100 mm Ø

**Clar**  
 Stirnlampe  
 Head Lamp  
 Eclaireur frontal  
 Lámpara frontal

**HB 118**  
 mit Stirnband aus Plastik, 100 mm Ø  
 with head band of plastic, 100 mm Ø  
 avec bandeau de plastique, 100 mm de Ø  
 con cinta de plástico, 100 mm de Ø

**HB 120**  
 mit Stirnband aus Celluloid, 100 mm Ø  
 with head band of celluloid, 100 mm Ø  
 avec bandeau de celluloid, 100 mm de Ø  
 con cinta de celuloide, 100 mm de Ø

**HB 121**  
 Stirnband aus Celluloid  
 Head band of celluloid  
 Bandeau de celluloid  
 Cinta de celuloide

**HB 123**  
 Ersatz-Birnchen, 6 V  
 Spare bulb, 6 V  
 Lampe de rechange, 6 V  
 Bombillas de repuesto, 6 V

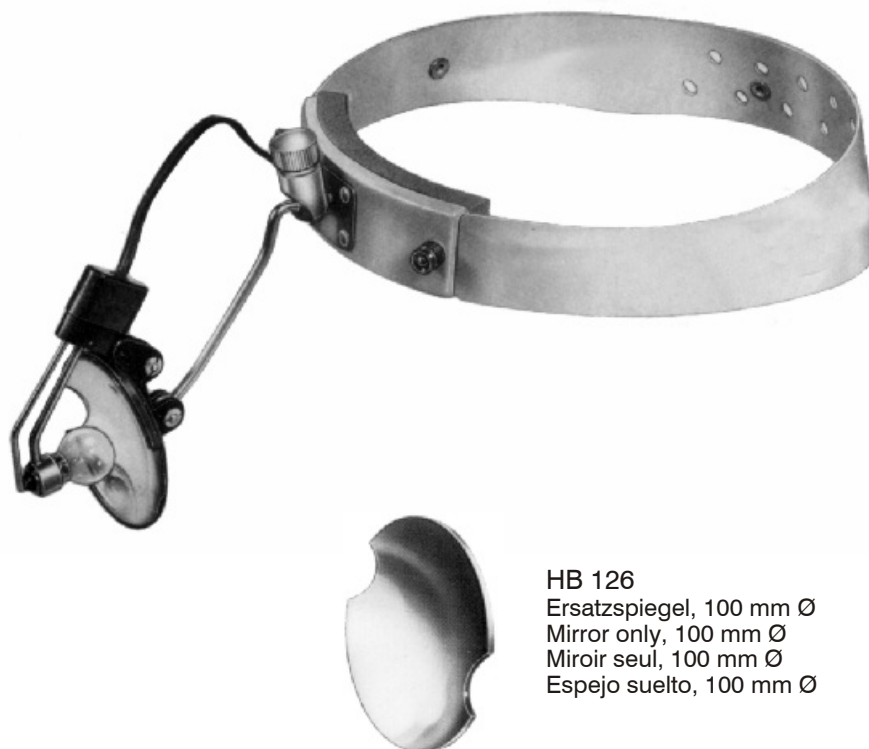

**Clar**  
 Stirnlampe  
 Head Lamp  
 Eclaireur frontal  
 Lámpara frontal

**HB 124**  
 mit Stirnband aus Celluloid  
 with head band of celluloid  
 avec bandeau de celluloid  
 con cinta de celuloide

**HB 125**  
 Stirnband aus Celluloid  
 Head band of celluloid  
 Bandeau de celluloid  
 Cinta de celuloide

**HB 126**  
 Ersatzspiegel, 100 mm Ø  
 Mirror only, 100 mm Ø  
 Miroir seul, 100 mm Ø  
 Espejo suelto, 100 mm Ø



**HB 127**  
 Ersatz-Birnchen, 6 V  
 Spare bulb, 6 V  
 Lampe de rechange, 6 V  
 Bombillas de repuesto, 6 V



**Schioetz**  
 Tonometer, Spez. 5  
 Tonometer, Spec. 5  
 Tonomètre, Spécif. 5  
 Tonómetro, Spec. 5



**HB 130**  
 gerade Skala  
 straight scale  
 cadre droit  
 escala recta

**HB 131**  
 schräge Skala  
 inclined scale  
 cadre courbe  
 escala inclinada

**HB 132**  
 Eichgebühr  
 rate for gauging  
 droits pour étallonnage  
 precio para aforo

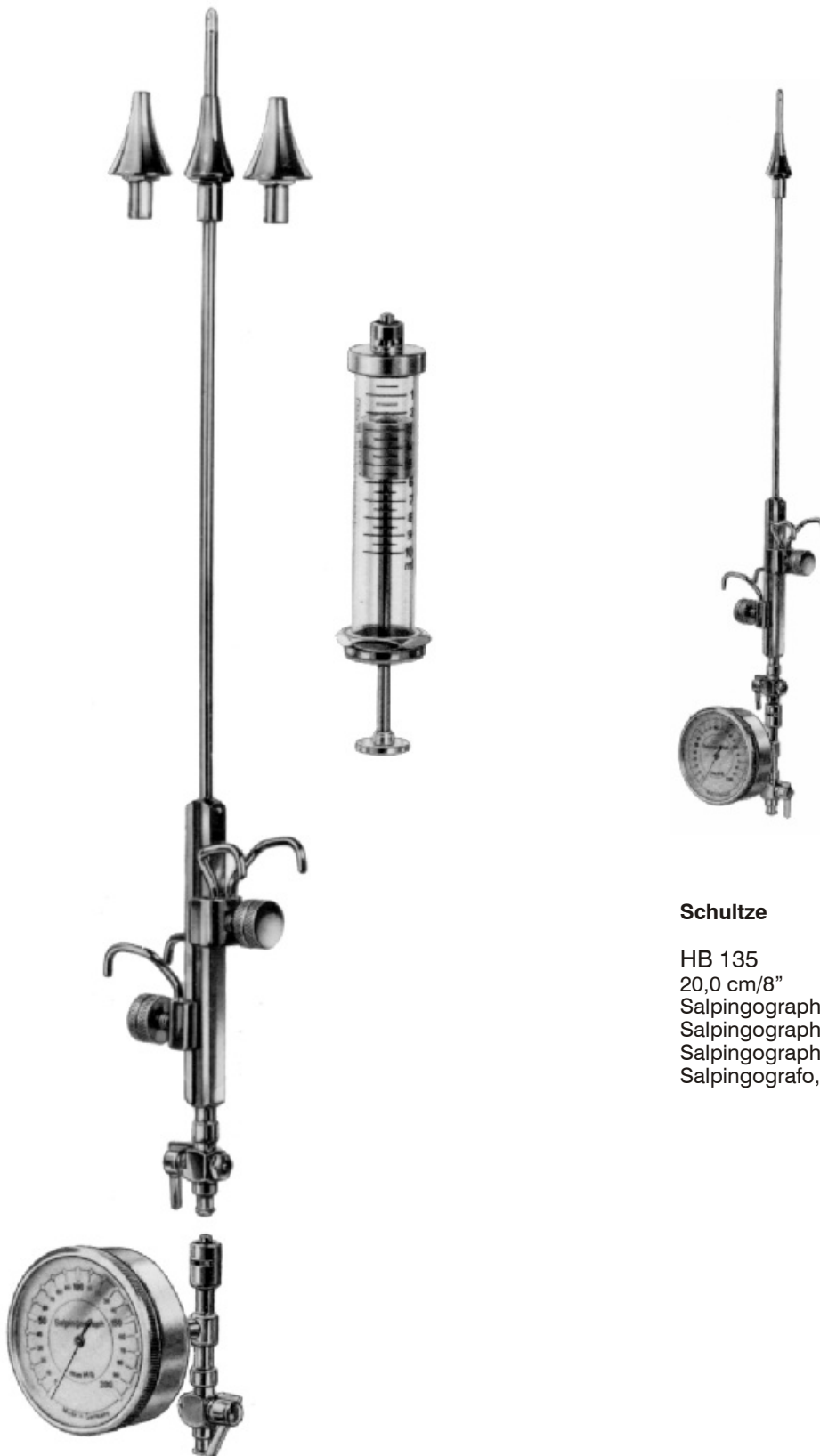

**Schultze**

HB 135  
20,0 cm/8"  
Salpingograph, komplett  
Salpingograph, complete  
Salpingographe, complet  
Salpingografo, completo

**Komprimeter  
Comprimeter  
Appareil compressif complet  
Aparato de compresión**



**HB 136**  
Komprimeter  
Comprimeter  
Appareil compressif complet  
Aparato de compresión

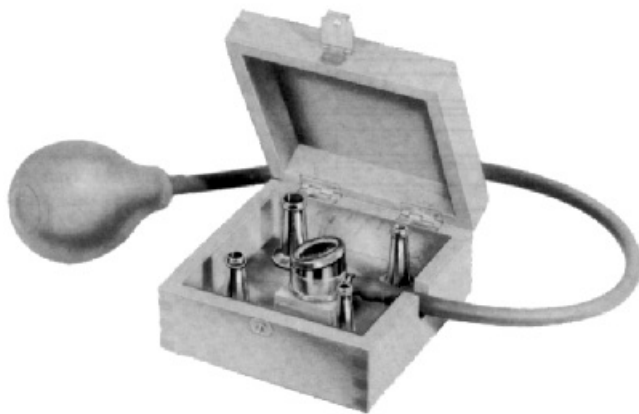

**Fig. 1**  
 HB 151  
 6 mm Ø



**Fig. 2**  
 HB 152  
 7,5 mm Ø



**Fig. 3**  
 HB 153  
 8,2 mm Ø

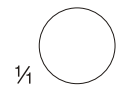

**Fig. 4**  
 HB 154  
 10 mm Ø

**Bruenings**

**HB 150**  
 Ohrspekula, komplett  
 Ear Specula, complete  
 Spéculum auriculaire, complet  
 Espéculo auricular, completo

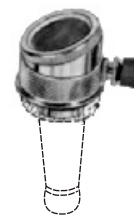

**HB 156**  
 Gummiball mit Schlauch, allein  
 Rubber Bulb and tube, only  
 Poire soufflante et tube, seule  
 Insuflador con tubo, solo

**HB 157**  
 Holzetui, allein  
 Wooden Case, only  
 Boîte en bois, seule  
 Estuche de madera, solo

**HB 155**  
 Kopfstück, allein  
 Head piece, only  
 Pièce de tête, seule  
 Pieza de cabeza, solo



**Hartmann**

Ohrspekula  
 Ear Specula  
 Spéculum auriculaire  
 Espéculo auricular



**Fig. 0**  
 HB 160  
 3,0 mm Ø



**Fig. 1**  
 HB 161  
 4,0 mm Ø



**Fig. 2**  
 HB 162  
 5,0 mm Ø



**Fig. 3**  
 HB 163  
 6,0 mm Ø

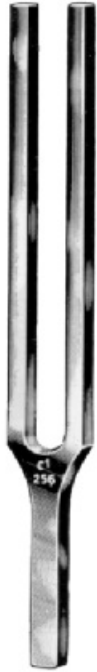

**Fig. 4**  
 HB 164  
 7,5 mm Ø





**Hartmann**  
c 128  
HB 180-00



**Hartmann**  
c¹ 256  
HB 180-01



**Hartmann**  
c² 312  
HB 180-02



**Hartmann**  
c³ 1024  
HB 180-03



**Hartmann**  
c⁴ 2048  
HB 180-04



**Hartmann**  
c⁵ 4096  
HB 180-05



**Hartmann**  
c 64  
HB 180-06



**Hartmann**  
c 128  
HB 180-07



**Hartmann**  
c¹ 256  
HB 180-08



**Hartmann**  
mit Fuß, with foot  
avec pied, con pie  
c¹ 256  
HB 180-09

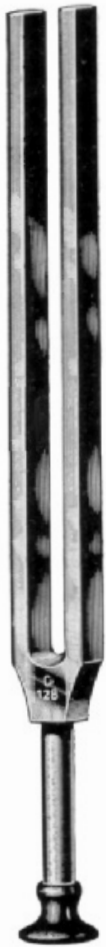

**Lucae**  
 c 128  
 HB 181-00



**Lucae**  
 c<sup>1</sup> 256  
 HB 181-01



**Lucae**  
 c<sup>2</sup> 512  
 HB 181-02



**Lucae**  
 c<sup>3</sup> 1024  
 HB 181-03



**Lucae**  
 c<sup>4</sup> 2048  
 HB 181-04



**Lucae**  
 c<sup>5</sup> 4096  
 HB 181-05



**Lucae**  
 c 128  
 HB 181-06



**French**  
 c<sub>2</sub> 16  
 Doppel-Contra  
 Double-contra  
 Double-contra  
 Doble-contra

HB 182-01



**French**  
 c<sub>1</sub> 32  
 Contra  
 Contra  
 Contra  
 Contra

HB 182-02



**Rydel-Seiffer**  
 C 64 / c 128  
 mit Dämpfern = C 64 / ohne Dämpfer = c 128  
 with clamps = C 64 / without clamps = c 128  
 avec curseurs = C 64 / sans curseurs = c 128  
 con sordinas = C 64 / sin sordinas = c 128

HB 183-01



Stimmgabel für neurologische Untersuchungen, mit Reflexhammer, Nadelrad, Pinsel und Nadel

Tuning fork for neurological examinations, with percussion hammer, pinwheel, brush, and needle

Diapason pour examens neurologiques, avec marteaux-percuteurs, roue aux épingles, brosse et aiguille

Diapasón para exámenes neurológicos, con martillo percusor, rueda con espinas, cepillo y aguja

HB 184-01



**Koenig**  
 A 109  
 verschiebbar bis g  
 variable up to g  
 variable jusqu' à g  
 variable hasta g

HB 185-01



a<sup>1</sup> 440  
 HB 186-01

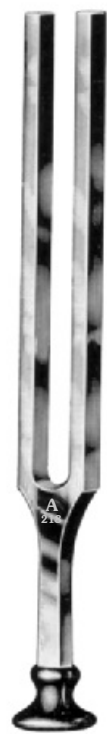

A 218  
 HB 186-02

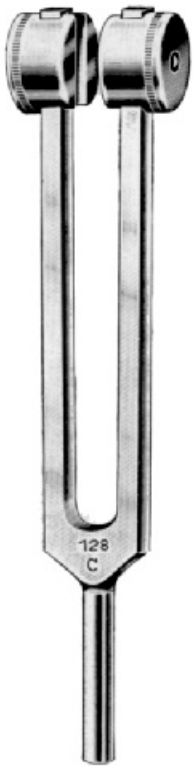

c 128  
HB 187-00



c<sup>1</sup> 256  
HB 187-01



c<sup>2</sup> 512  
HB 187-02



c<sup>3</sup> 1024  
HB 187-03



c<sup>4</sup> 2048  
HB 187-04

Stimmgabeln aus Spezial Aluminium-Magnesium-Legierung für medizinische Zwecke z. B. für Gehörprüfungen (Luft- und Knochenleitung), für Sensibilitätsprüfungen und andere diagnostische Zwecke.

Tuning forks made from special aluminium-magnesium-alloy, for medical purposes, such as examination of hearing (air and bone conduction), for sensibility examinations, and other diagnostic purposes.

Diapasons faits d' un alliage spécial d' aluminium et de magnésium, à des fins médicales, telles que l' examen de l' ouïe (conduite de l' air et os) et l' examen de la sensibilité et tout autre diagnostique.

Diapasón de una aleación especial al aluminio y magnesio, destinado a fines médicos por ejemplo, reconocimiento del oído (conduito del aire y huesos), reconocimiento de la sensibilidad y otros fines diagnósticos.



**HB 188-00**

Satz zu 5 Spezial Aluminium-Magnesium-Legierung Stimmgabeln im Etui  
Set of 5 special aluminium-magnesium-alloy tuning forks in a case  
Jeu de 5 diapasons, alliage spécial aluminium/magnésium dans un étui  
Juego de 5 diapasones de una aleación especial de aluminio y magnesio en estuche  
(HB 187-00, HB 187-01, HB 187-02, HB 187-03, HB 187-04)



**HB 189-05**

Satz zu 5 Hartmann Stimmgabeln im Etui  
Set of 5 Hartmann tuning forks in a case  
Jeu de 5 Hartmann diapasons dans un étui  
Juego de 5 Hartmann diapasones en estuche  
(HB 180-02, HB 180-03, HB 180-04, HB 180-07, HB 180-08)

Stimmgabeln  
Tuning forks  
Diapasons  
Diapasónes

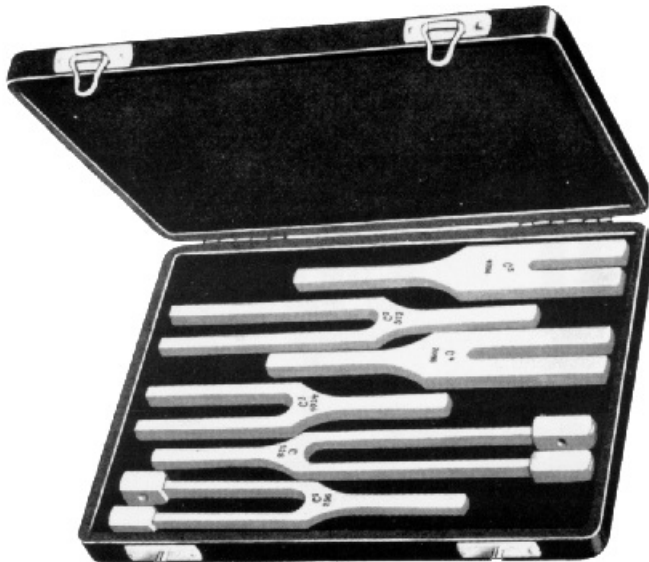

HB 189-06  
Satz zu 6 Hartmann Stimmgabeln im Etui  
Set of 6 Hartmann tuning forks in a case  
Jeu de 6 Hartmann diapasons dans un étui  
Juego de 6 Hartmann diapasones en estuche  
(HB 180-02, HB 180-03, HB 180-04,  
HB 180-05, HB 180-07, HB 180-08)



HB 189-08  
Satz zu 8 Hartmann Stimmgabeln im Etui  
Set of 8 Hartmann tuning forks in a case  
Jeu de 8 Hartmann diapasons dans un étui  
Juego de 8 Hartmann diapasones en estuche  
(HB 180-02, HB 180-03, HB 180-04, HB 180-05,  
HB 180-06, HB 180-07, HB 180-08, HB 182-02)

