

Gynäkologie, Geburtshilfe
Gynecology, Obstetrics
Gynécologie, Accouchement
Ginecología, Obstetricia





Kristeller

HB 4700

70 x 15 mm
 Satz, set, jeu, juego

für Kinder
 for children
 pour enfants
 para niños

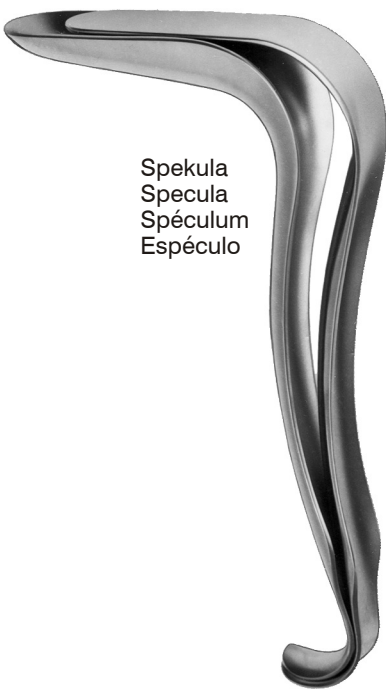

Spekula
 Specula
 Spéculum
 Espéculo

Halter
 Retractor
 Valve
 Valva

Kristeller
 kurzes Modell
 short model
 modèle court
 modelo corto

Satz aus je 1 Spekula und 1 Halter
 Set of 1 specula and 1 retractor
 Jeu de 1 spéculum et 1 valve
 Juego de 1 espéculo y 1 valva

Fig. 1 HB 4701
Fig. 2 HB 4702
Fig. 3 HB 4703

Spekula
 Specula
 Spéculum
 Espéculo

Fig. 1 HB 4701-01 70 x 27 mm
Fig. 2 HB 4702-02 80 x 30 mm
Fig. 3 HB 4703-03 90 x 36 mm

Halter
 Retractor
 Valve
 Valva

Fig. 1 HB 4701-11 75 x 23 mm
Fig. 2 HB 4702-12 85 x 26 mm
Fig. 3 HB 4703-13 100 x 32 mm

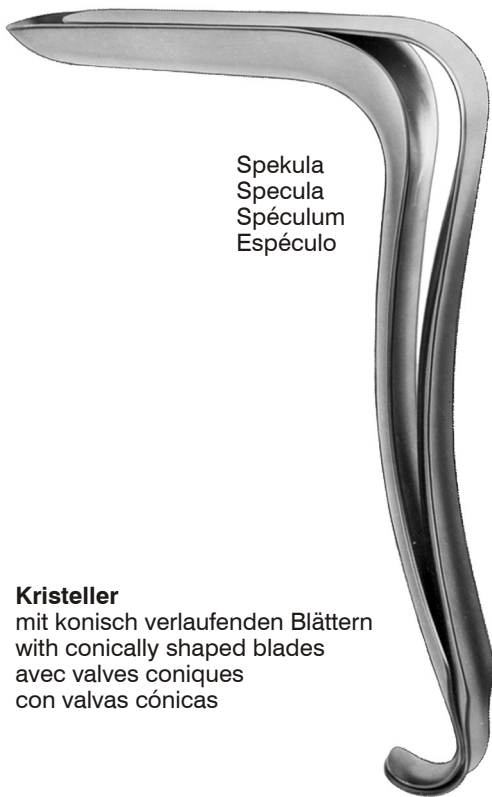

Spekula
 Specula
 Spéculum
 Espéculo

Halter
 Retractor
 Valve
 Valva

Satz aus je 1 Spekula und 1 Halter
 Set of 1 specula and 1 retractor
 Jeu de 1 spéculum et 1 valve
 Juego de 1 espéculo y 1 valva

Fig. 00 HB 4709
Fig. 0 HB 4710

Spekula
 Specula
 Spéculum
 Espéculo

Fig. 00 HB 4709-01 105 x 18 mm
Fig. 0 HB 4710-01 105 x 21 mm

Kristeller
 mit konisch verlaufenden Blättern
 with conically shaped blades
 avec valves coniques
 con valvas cónicas

Halter
 Retractor
 Valve
 Valva

Fig. 00 HB 4709-11 110 x 14 mm
Fig. 0 HB 4710-11 110 x 17 mm

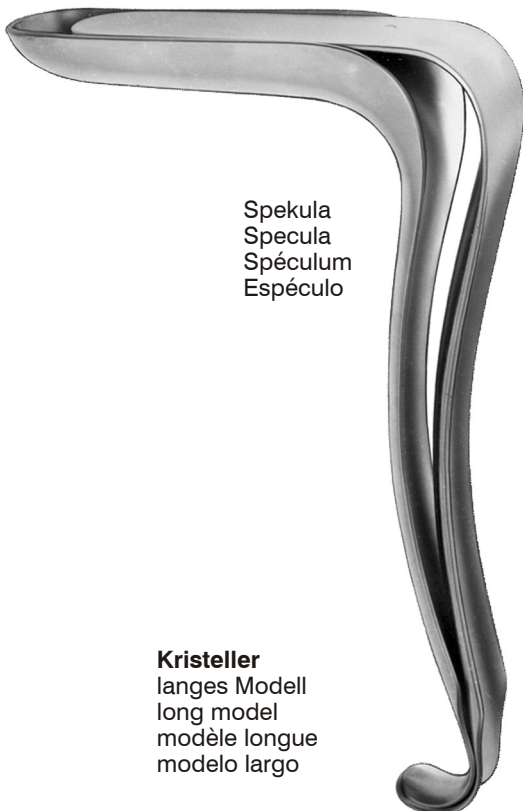

Spekula
 Specula
 Spéculum
 Espéculo

Halter
 Retractor
 Valve
 Valva

Satz aus je 1 Spekula und 1 Halter
 Set of 1 specula and 1 retractor
 Jeu de 1 spéculum et 1 valve
 Juego de 1 espéculo y 1 valva

Fig. 1 HB 4721
Fig. 2 HB 4722
Fig. 3 HB 4723

Spekula
 Specula
 Spéculum
 Espéculo

Fig. 1 HB 4721-01 105 x 26 mm
Fig. 2 HB 4722-02 105 x 28 mm
Fig. 3 HB 4723-03 105 x 33 mm

Kristeller
 langes Modell
 long model
 modèle longue
 modelo largo

Halter
 Retractor
 Valve
 Valva

Fig. 1 HB 4721-11 115 x 22 mm
Fig. 2 HB 4722-12 115 x 24 mm
Fig. 3 HB 4723-13 115 x 29 mm

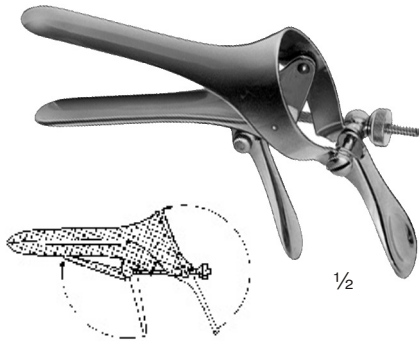

Cusco

HB 4800 85 x 17 mm
 für Jungfrauen
 for virgins
 pour vierges
 para virgenes

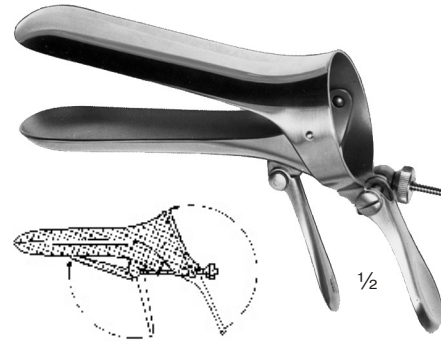

Cusco

Fig. 1 HB 4801 75 x 32 mm
 Fig. 2 HB 4802 85 x 35 mm
 Fig. 3 HB 4803 100 x 35 mm

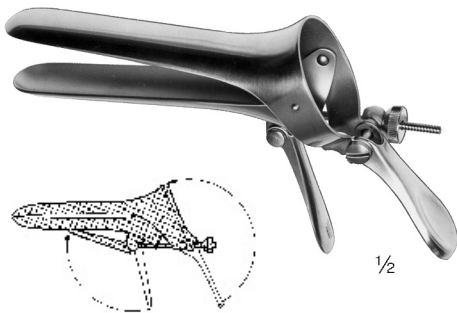

Cusco

Fig. 1 HB 4805 90 x 23/25 mm
 Fig. 2 HB 4806 100 x 25/27 mm
 Fig. 3 HB 4807 110 x 27/30 mm

Schweizer Modell
 Swiss pattern
 Modèle suisse
 Modelo suizo



Grave

Fig. 1 HB 4811 85 x 33 mm
 Fig. 2 HB 4812 95 x 33 mm
 Fig. 3 HB 4813 105 x 33 mm



Seyffert
 23,0 cm/9"

HB 4816-01 100 x 17 mm
 HB 4816-02 110 x 33 mm

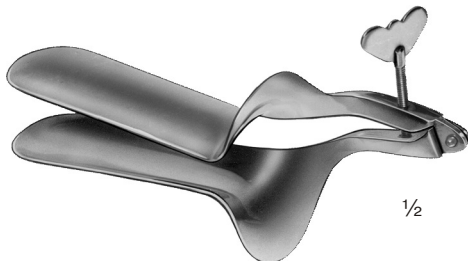

Collin

Fig. 1 HB 4821 90 x 29 mm
Fig. 2 HB 4822 95 x 35 mm
Fig. 3 HB 4823 110 x 40 mm

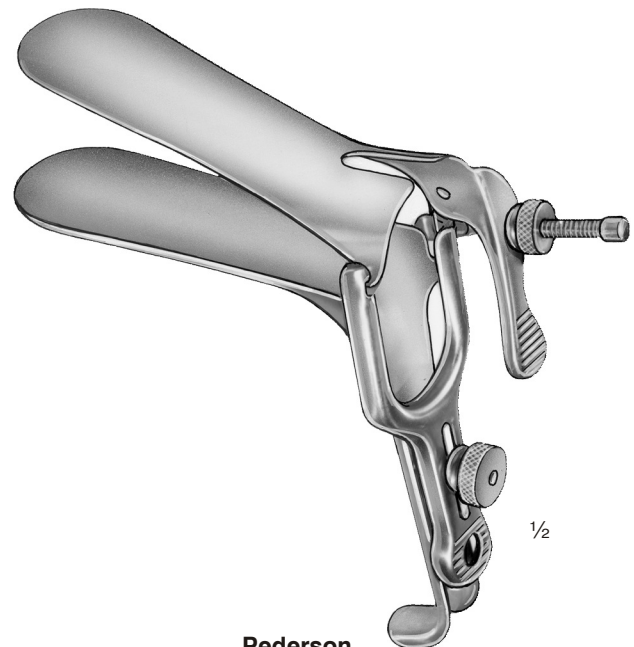

Pederson

Fig. 1 HB 4824 75 x 13 mm
Fig. 2 HB 4825 100 x 22 mm
Fig. 3 HB 4826 120 x 25 mm

Scheidenspekula für Laserchirurgie
Vaginal Specula for Laser Surgery
Spéculums vaginaux pour chirurgie laser
Espéculos vaginales para la cirugía láser



mit Absaugung
 with smoke tube
 avec tube d'aspiration
 con tubo de aspiración

1/2

Grave

- Fig. 1** HB 4811L 85 x 33 mm
Fig. 2 HB 4812L 95 x 33 mm
Fig. 3 HB 4813L 105 x 33 mm



mit Absaugung
 with smoke tube
 avec tube d'aspiration
 con tubo de aspiración

1/2

Pederson

- Fig. 1** HB 4824L 75 x 13 mm
Fig. 2 HB 4825L 100 x 22 mm
Fig. 3 HB 4826L 120 x 25 mm

Isoliert für Laser- und Elektrochirurgie HB-Nr. + "L"
 Insulated for Laser- and Electrosurgery HB-No. + "L"
 Isolé pour les interventions au laser et électrochirurgical HB-No. + "L"
 Aislado para láser y electrocirugía HB-No. + "L"



Semm

- Fig. 1** HB 4827 95 x 14/18 mm
Fig. 2 HB 4828 100 x 20/25 mm
Fig. 3 HB 4829 105 x 27/35 mm

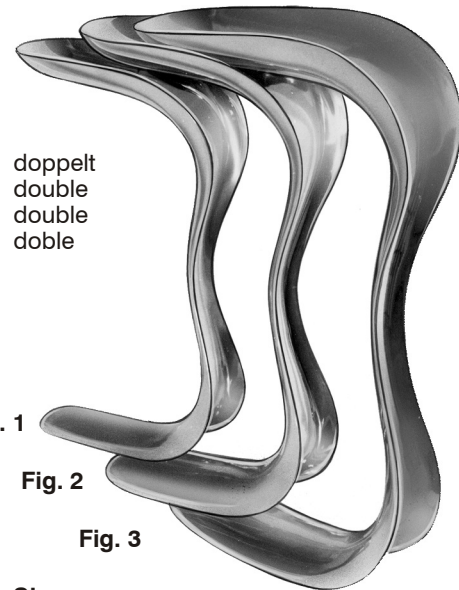

doppelt
 double
 double
 double

Fig. 1

Fig. 2

Fig. 3

Sims

- Fig. 1** HB 4831 25 x 30 mm
Fig. 2 HB 4832 30 x 35 mm
Fig. 3 HB 4833 35 x 40 mm



Spekula
 Specula
 Spéculum
 Espéculo

- Fig. 1** HB 4834-01 70 x 40 mm
Fig. 2 HB 4834-02 90 x 40 mm



Halter
 Retractor
 Valve
 Valva

- Fig. 1** HB 4835-01 70 x 33 mm
Fig. 2 HB 4835-02 90 x 33 mm

Kallmorgen

Satz aus je 1 Spekula und 1 Halter
 Set of 1 specula and 1 retractor
 Jeu de 1 spéculum et 1 valve
 Juego de 1 espéculo y 1 valva

- Fig. 1** HB 4836-01 17,0 cm/6³/₄"
Fig. 2 HB 4836-02 20,0 cm/8"

Scheidenspekula
Vaginal Specula
Spéculum vaginaux
Espéculos vaginales



Breisky

29,0 cm/11½"

- HB 4837-20 100 x 20 mm
- HB 4837-25 100 x 25 mm
- HB 4837-30 100 x 30 mm
- HB 4837-35 100 x 35 mm
- HB 4837-40 100 x 40 mm

32,0 cm/12½"

- HB 4838-20 130 x 20 mm
- HB 4838-25 130 x 25 mm
- HB 4838-30 130 x 30 mm
- HB 4838-35 130 x 35 mm
- HB 4838-40 130 x 40 mm

35,0 cm/13¾"

- HB 4839 155 x 40 mm

½



Doyen

- HB 4840 70 x 30 mm
- 24,0 cm/9½"

½

Scheidenspekula
 Vaginal Specula
 Spéculums vaginaux
 Espéculos vaginales



Spekula
 Specula
 Spéculum
 Espéculo

Halter
 Retractor
 Valve
 Valva

Mathieu

21,0 cm/8¼"

Spekula
 Specula
 Spéculum
 Espéculo

HB 4840-01 95 x 17-30 mm

Halter
 Retractor
 Valve
 Valva

HB 4840-02 95 x 17-26 mm

½

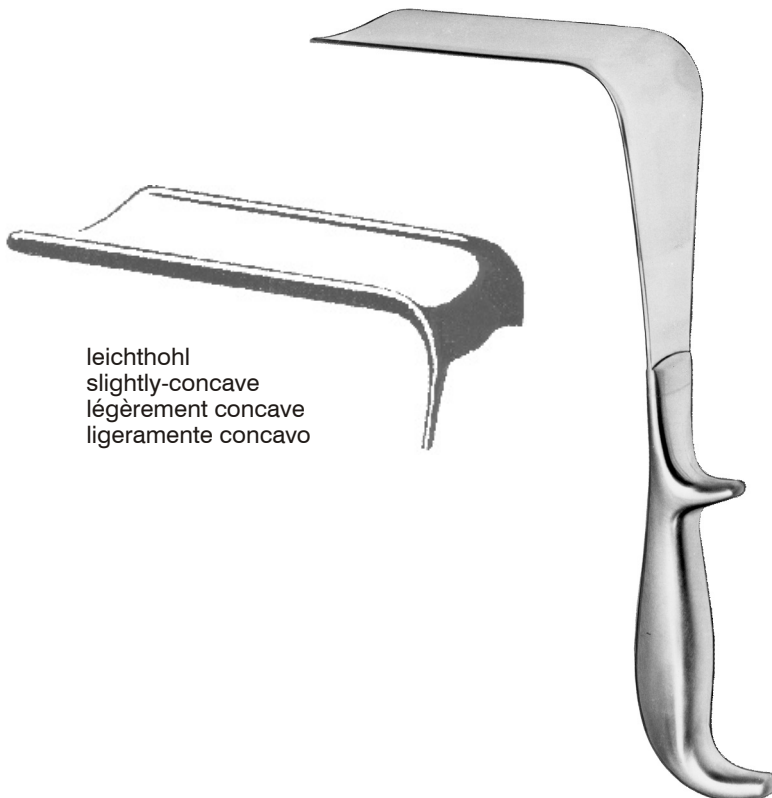

leichthohl
 slightly-concave
 légèrement concave
 ligeramente concavo

Doyen

- Fig. 1 HB 4841 60 x 35 mm
- Fig. 2 HB 4842 90 x 35 mm
- Fig. 3 HB 4843 120 x 35 mm
- Fig. 4 HB 4844 160 x 35 mm

- Fig. 1 HB 4851 60 x 45 mm
- Fig. 2 HB 4852 90 x 45 mm
- Fig. 3 HB 4853 120 x 45 mm
- Fig. 4 HB 4854 160 x 45 mm

- Fig. 1 HB 4861 60 x 60 mm
- Fig. 2 HB 4862 90 x 60 mm
- Fig. 3 HB 4863 120 x 60 mm
- Fig. 4 HB 4864 160 x 60 mm

Lateral Vaginal-Retractor
Lateral Vaginal Retractor
Spéculum latéral
Espéculos laterales

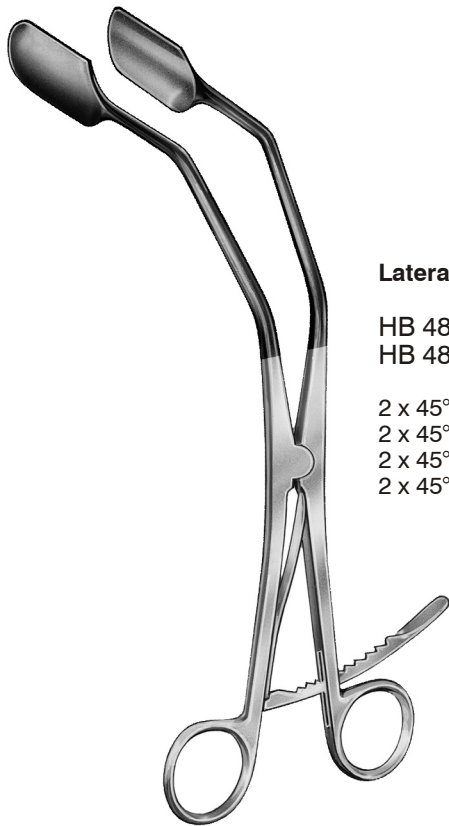

Lateral Retraktor

HB 4865
 HB 4865L

2 x 45° gebogen
 2 x 45° curved
 2 x 45° courbe
 2 x 45° curva

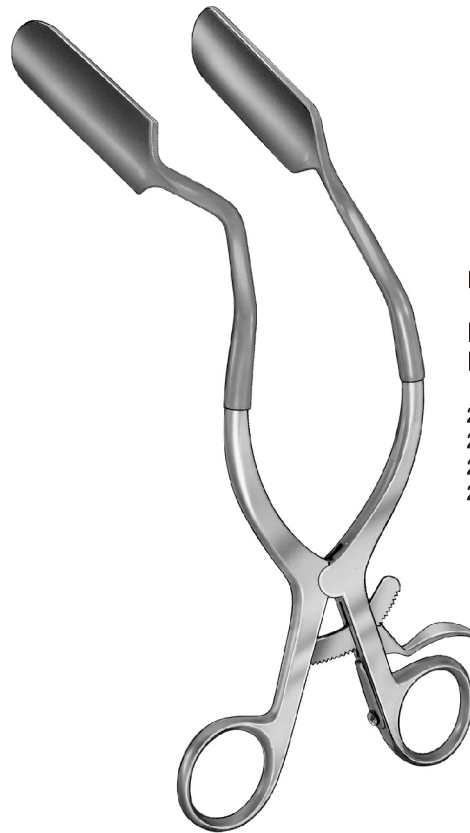

Lateral Retraktor

HB 4866
 HB 4866L

2 x 45° gebogen
 2 x 45° curved
 2 x 45° courbe
 2 x 45° curva

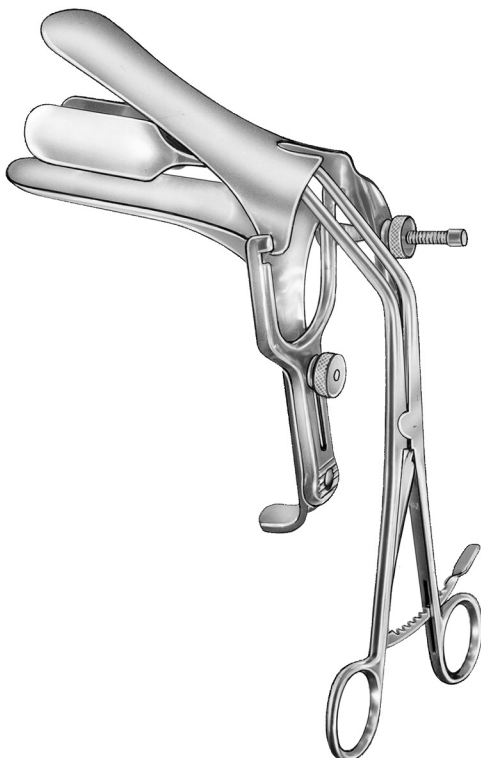

Der Lateral Vaginal-Retraktor erweitert Ihr Blickfeld und den Arbeitsbereich.

The Lateral Vaginal Retractor improves access and viewing of the cervix during a procedure.

Le spéculum latéral élargit votre angle visuel et votre sphère du travail.

El espéculo lateral amplia su campo visual y su zona de trabajo.

Isoliert für Laser- und Elektrochirurgie HB-Nr. + "L"
 Insulated for Laser- and Electrosurgery HB-No. + "L"
 Isolé pour les interventions au laser et électrochirurgical HB-No. + "L"
 Aislado para láser y electrocirugía HB-No. + "L"

75 x 38 mm



Auvard

HB 4870

mit abnehmbaren Gewicht
 with detachable weight
 avec poids démontable
 con peso desmontable

HB 4871

mit festem Gewicht
 with fixed weight
 avec poids fixe
 con peso fijo



Scherbak

HB 4873-00

Satz bestehend aus Gewicht (HB 4873-40),
 Griff und 5 Blättern
 Set consisting of weight (HB 4873-40),
 handle and 5 blades
 Jeu composé de poids (HB 4873-40),
 manche et 5 valves
 Juego compuesto de peso (HB 4873-40),
 mango y 5 valvas

HB 4873-10

Griff allein
 Handle only
 Manche seul
 Mango suelto

HB 4873-40 400 g

HB 4873-80 800 g

Gewicht allein
 Weight only
 Poids seul
 Peso suelto

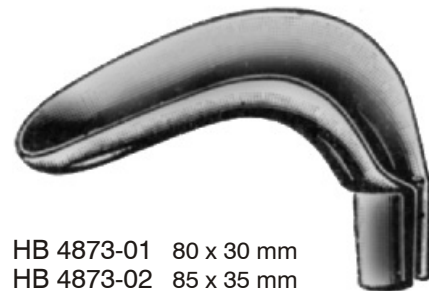

HB 4873-01 80 x 30 mm

HB 4873-02 85 x 35 mm

HB 4873-03 90 x 40 mm



HB 4873-04 55 x 40/60 mm

HB 4873-05 70 x 45/70 mm

Endospekula
 Endospecula
 Endospéculums
 Endospéculos



1/2

Kogan
 28 cm/11"

mit Sperre
 with ratchet
 avec crémaillère
 con cremallera

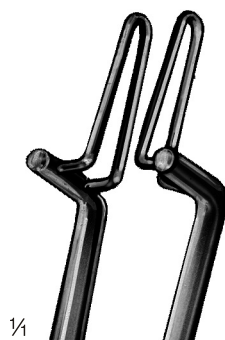

1/4

4 x 23 mm
 HB 4875
 HB 4875L

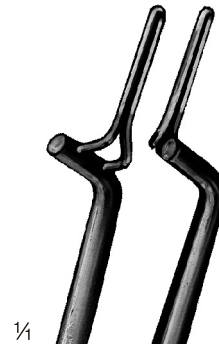

1/4

3 x 23 mm
 HB 4877
 HB 4877L

6 x 23 mm
 HB 4876
 HB 4876L

Isoliert für Laser- und Elektrochirurgie HB-Nr. + "L"
 Insulated for Laser- and Electrosurgery HB-No. + "L"
 Isolé pour les interventions au laser et électrochirurgical HB-No. + "L"
 Aislado para láser y electrocirugía HB-No. + "L"



Kogan

HB 4878
24 cm/9 1/2"

ohne Sperre
without ratchet
sans crémaillère
sin cremallera



Kogan

HB 4879
24 cm/9 1/2"

mit Schraubensperre
with screw ratchet
avec crémaillère de vis
con cremallera de tornillo

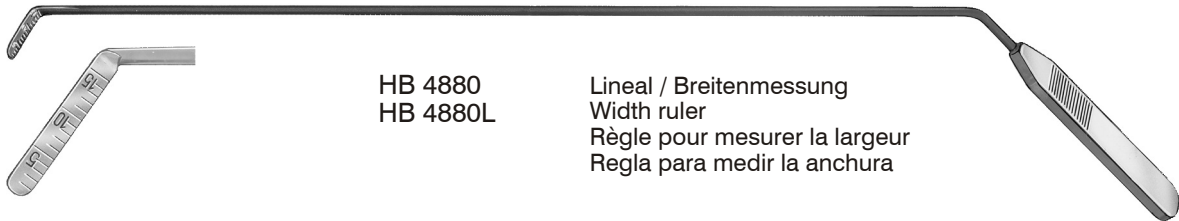

HB 4880
HB 4880L

Lineal / Breitenmessung
Width ruler
Règle pour mesurer la largeur
Regla para medir la anchura

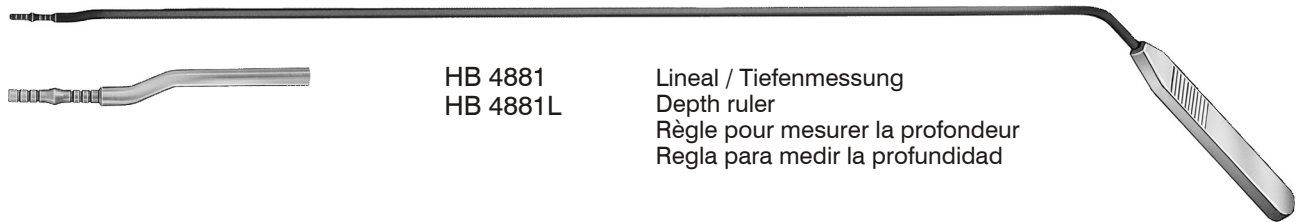

HB 4881
HB 4881L

Lineal / Tiefenmessung
Depth ruler
Règle pour mesurer la profondeur
Regla para medir la profundidad



HB 4884
HB 4884L

Emmett
Haken
Hook
Crochet
Gancho



HB 4885
HB 4885L

Laser Haken
Laser hook
Crochet à laser
Gancho para láser



HB 4886
HB 4886L

Iris Haken
Iris hook
Crochet à iris
Gancho para iris



HB 4887
HB 4887L

Haken, 2 Krallen
Hook, 2 clutches
Crochet, 2 griffes
Gancho, 2 garras

Isoliert für Laser- und Elektrochirurgie HB-Nr. + "L"
 Insulated for Laser- and Electrosurgery HB-No. + "L"
 Isolé pour les interventions au laser et électrochirurgical HB-No. + "L"
 Aislado para láser y electrocirugía HB-No. + "L"

**Uterusdilatoren
Uterine-Dilators
Dilatateurs utérins
Dilatadores uterinos**



	mm
HB 4729-03	3
HB 4729-04	4
HB 4729-05	5
HB 4729-06	6
HB 4729-07	7
HB 4729-08	8
HB 4729-09	9
HB 4729-10	10
HB 4729-11	11
HB 4729-12	12
HB 4729-13	13
HB 4729-14	14
HB 4729-15	15
HB 4729-16	16
HB 4729-17	17
HB 4729-18	18
HB 4729-19	19
HB 4729-20	20
HB 4729-21	21
HB 4729-22	22
HB 4729-23	23

Hegar
mit gerieftem Griff und Rinne
with serrated handle and groove
avec manche strié et cannelure
con mango estriado y acanaladura



Hegar
mit glattem Muldengriff
with sloped handle
avec manche aplati
con mango aplanado

	mm		mm
HB 4730	1	HB 4760	1,5
HB 4731	2	HB 4761	2,5
HB 4732	3	HB 4762	3,5
HB 4733	4	HB 4763	4,5
HB 4734	5	HB 4764	5,5
HB 4735	6	HB 4765	6,5
HB 4736	7	HB 4766	7,5
HB 4737	8	HB 4767	8,5
HB 4738	9	HB 4768	9,5
HB 4739	10	HB 4769	10,5
HB 4740	11	HB 4770	11,5
HB 4741	12	HB 4771	12,5
HB 4742	13	HB 4772	13,5
HB 4743	14	HB 4773	14,5
HB 4744	15	HB 4774	15,5
HB 4745	16	HB 4775	16,5
HB 4746	17	HB 4776	17,5
HB 4747	18	HB 4777	18,5
HB 4748	19	HB 4778	19,5
HB 4749	20	HB 4779	20,5
HB 4750	21	HB 4780	21,5
HB 4751	22	HB 4781	22,5
HB 4752	23	HB 4782	23,5
HB 4753	24		
HB 4754	25		
HB 4755	26		
HB 4756	27		
HB 4757	28		
HB 4758	29		
HB 4759	30		

Satz Set Jeu Juego	mm	Stück per Satz Pieces per set Pièces par jeu Piezas por juego
HB 4901	4-17	14
HB 4902	1-26	26

**Uterusdilatoren
Uterine-Dilators
Dilatateurs utérins
Dilatadores uterinos**



Hegar
mit glattem Muldengriff in Ledertasche
with sloped handle in leather pouch
avec manche aplati en pochette de cuir
con mango aplanado en estuche de cuero

Satz Set Jeu Juego	mm	Stück per Satz Pieces per set Pièces par jeu Piezas por juego
HB 4903	4-17	14



Hegar
mit glattem Muldengriff in Metalletui
with sloped handle in metal case
avec manche aplati en boîte de métal
con mango aplanado en estuche de metal

Satz Set Jeu Juego	mm	Stück per Satz Pieces per set Pièces par jeu Piezas por juego
HB 4904	4-17	14
HB 4905	1-26	26

Metalletui allein, für: Metal case only, for: Boîte de métal seule, pour: Estuche de metal suelto, para:	mm	Stück Pieces Pièces Piezas
HB 4904-10	4-17	14
HB 4905-10	1-26	26

**Uterusdilatoren
Uterine-Dilators
Dilatateurs utérins
Dilatadores uterinos**



Hegar
doppelt
double
double
doble

	mm
HB 4784	1/2
HB 4785	3/4
HB 4786	5/6
HB 4787	7/8
HB 4788	9/10
HB 4789	11/12
HB 4790	13/14
HB 4791	15/16
HB 4792	17/18
HB 4793	19/20
HB 4794	21/22
HB 4795	23/24
HB 4796	25/26

Satz Set Jeu Juego	mm	Stück per Satz Pieces per set Pièces par jeu Piezas por juego
HB 4908	3/4 - 17/18	8
HB 4909	1/2 - 25/26	13



Hegar

doppelt, double, double, doble
in Stofftasche, in canvas roll,
en pochette à toile, en estuche de tela

Satz Set Jeu Juego	mm	Stück per Satz Pieces per set Pièces par jeu Piezas por juego
HB 4910	3/4 - 17/18	8



Hegar

doppelt, double, double, doble
in Metalletui, in metal case,
en boîte de métal, en estuche de metal

Satz Set Jeu Juego	mm	Stück per Satz Pieces per set Pièces par jeu Piezas por juego
HB 4911	3/4 - 17/18	8
HB 4912	1/2 - 25/26	13

Metalletui allein, für:
Metal case only, for:
Boîte de métal seule, pour:
Estuche de metal suelto, para:

	mm	Stück Pieces Pièces Piezas
HB 4908-10	3/4 - 17/18	8
HB 4909-10	1/2 - 25/26	13

Uterusdilatoren
Uterine-Dilators
Dilatateurs utérins
Dilatadores uterinos

Uterussonden
Uterine Sounds
Hystéromètres
Histerómetros

Uterus-Depressoren
Uterine depressors
Depresseurs utérins
Depresores uterinos



Uterusdilatoren
 Uterine-Dilators
 Dilatateurs utérins
 Dilatadores uterinos

Amerikanische Skala
 American scale
 Echelle américaine
 Escala americana

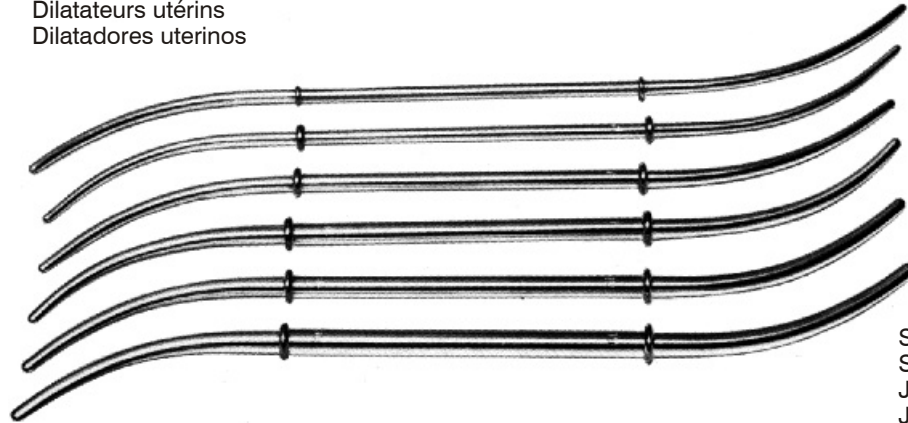

Hank		mm
Fig. 9/10	HB 4913-09	4,5/5
Fig. 11/12	HB 4913-11	5,5/6
Fig. 13/14	HB 4913-13	6,5/7
Fig. 15/16	HB 4913-15	7,5/8
Fig. 17/18	HB 4913-17	8,5/9
Fig. 19/20	HB 4913-19	9,5/10

Satz	Stück per Satz
Set	Pieces per set
Jeu	Pièces par jeu
Juego	Piezas por juego

HB 4913-00 9/10 - 19/20 6

Uterussonden
 Uterine Sounds
 Hystéromètres
 Histerómetros



Sims
 32 cm/12½"

HB 4920

starr, graduiert in cm
 rigid, graduated in cm
 rigide, gradué en cm
 rigido, graduado en cm

HB 4921

biegsam, graduiert in cm
 malleable, graduated in cm
 malléable, gradué en cm
 maleable, graduado en cm



biegsam
 malleable
 malléable
 maleable

Martin

HB 4923
 32 cm/12½"

Uterus-Depressor
 Uterine depressor
 Depresseur utérin
 Depresor uterino



Braun

HB 4924
 27,5 cm/11"

Hakenzangen
Tenaculum Forceps
Pinces à griffes
Pinzas para coger el cuello del útero

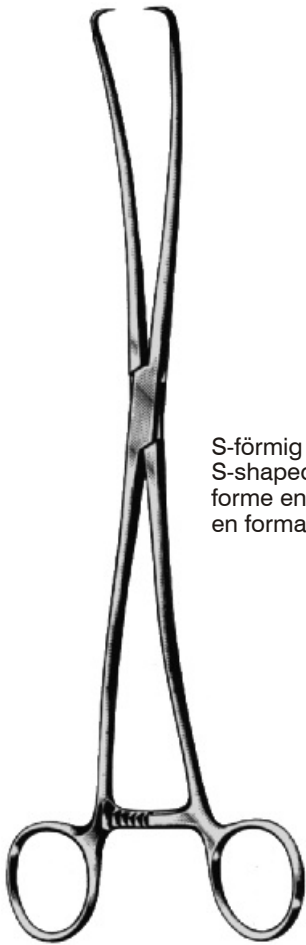

Duplay

HB 4949
 25,0 cm/10"

S-förmig
 S-shaped
 forme en S
 en forma de S

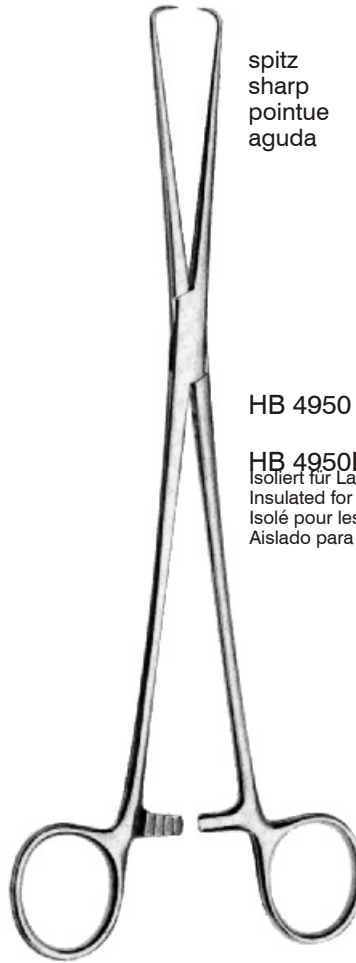

Schröder-Braun
 25,0 cm/10"

spitz
 sharp
 pointue
 aguda

HB 4950

HB 4950L
 Isoliert für Laser- und Elektrochirurgie
 Insulated for Laser- and Electrosurgery
 Isolé pour les interventions au laser et électrochirurgical
 Aislado para láser y electrocirugía



stumpf
 blunt
 mousse
 roma

HB 4952

HB 4952L



Braun

HB 4951



Skene

HB 4953

Hakenzangen
Tenaculum Forceps
Pinces à griffes
Pinzas para coger el cuello del útero



Staude-Moore

HB 4954
17,0 cm/6¾"



Czerny

HB 4959
20,0 cm/8"

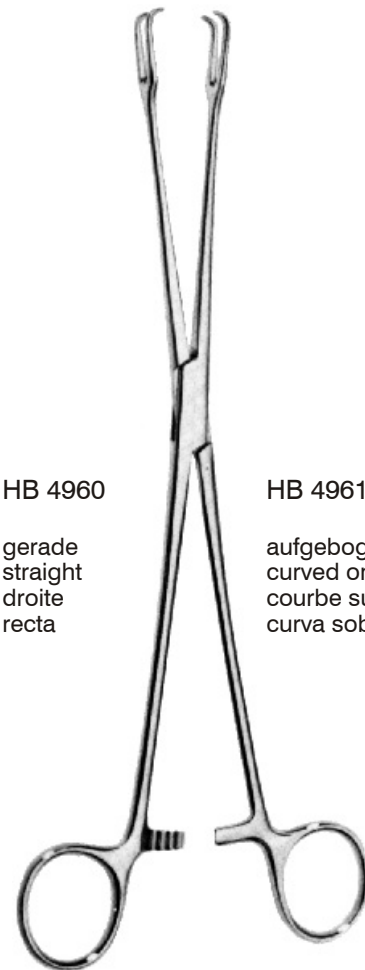

HB 4960

gerade
straight
droite
recta

HB 4961

aufgebogen
curved on flat
courbe sur le plat
curva sobre el plano

Schröder
24,0 cm/9½"

Hakenzangen
Tenaculum Forceps
Pinces à griffes
Pinzas para coger el cuello del útero



Teale
 HB 4962
 23,0 cm/9"

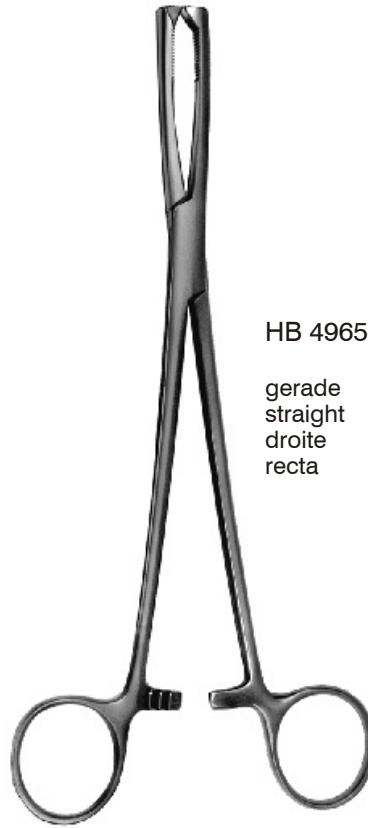

HB 4965
 gerade
 straight
 droite
 recta

HB 4966
 aufgebogen
 curved on flat
 courbe sur le plat
 curva sobre el plano

HB 4967
 seitwärts gebogen
 curved sideways
 courbe sur le côté
 curva lateral

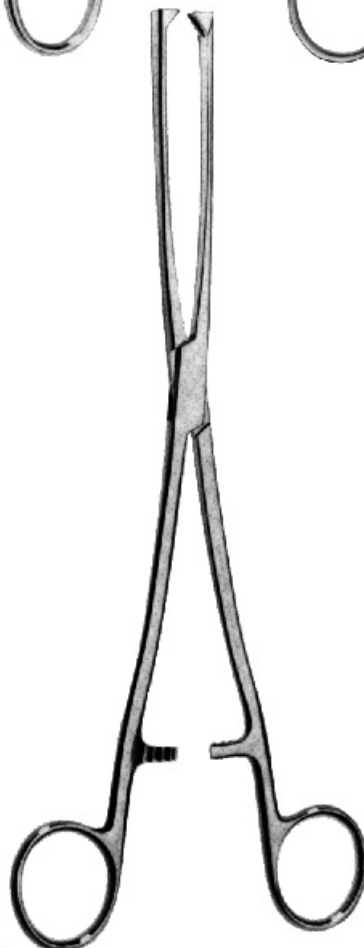

gerade
 straight
 droite
 recta

seitwärts gebogen
 curved sideways
 courbe sur le côté
 curva lateral

6 mm

HB 4970



HB 4973

8 mm

HB 4971



HB 4974

10 mm

HB 4972



HB 4975

Museux
 24,0 cm/9½"

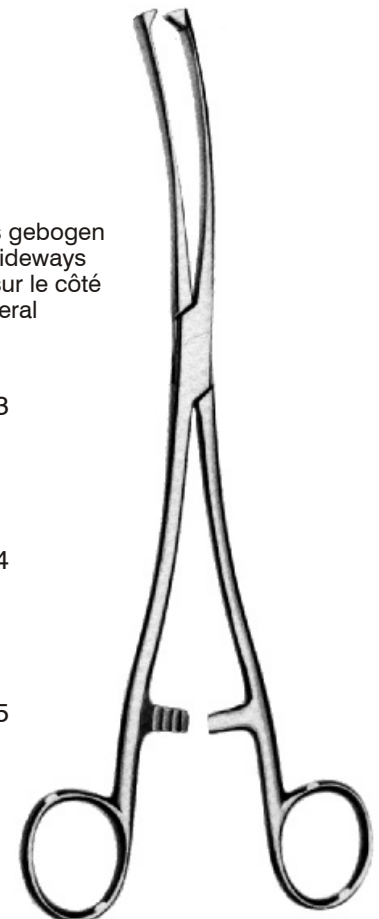

Uterus-Polypenzangen
Uterine Polypus Forceps
Pinces à polypes utérins
Pinzas para polipos uterinos

Uterus-Faßzangen
Uterine Elevating Forceps
Pinces hystérolabes
Pinzas para el útero



Uterus-Polypenzangen
Uterine Polypus Forceps
Pinces à polypes utérins
Pinzas para polipos uterinos

Uterus-Polypenzangen
Uterine Polypus Forceps
Pinces à polypes utérins
Pinzas para polipos uterinos



Noto

HB 4989
27,0 cm/10½"

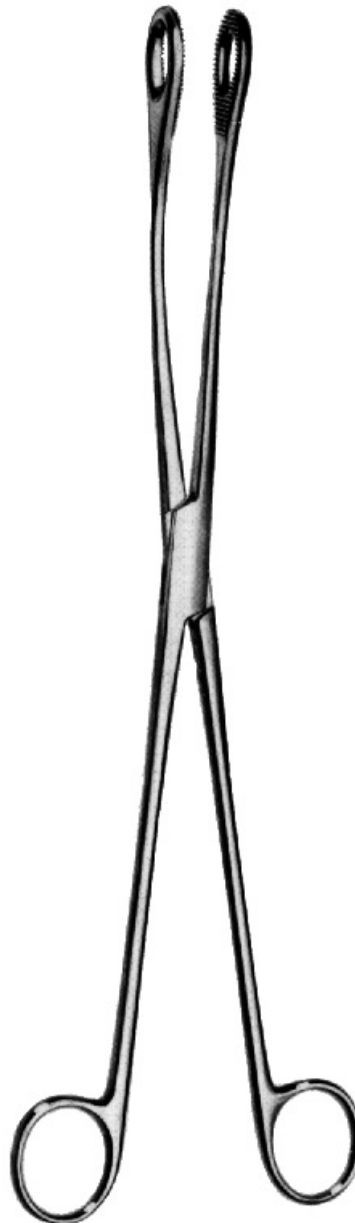

Kelly

HB 4990
32,0 cm/12½"

Ovarien-Faßzange
Ovarian Elevating Forceps
Pinces pour les ovaires
Pinzas para ovarios



Doyen

HB 4995
20,0 cm/8"

Uterus-Faßzangen
Uterine Elevating Forceps
Pinces hystérolabes
Pinzas para el útero

Myomheber
Myoma Screw
Tracteur de fibrome
Tiramiomas

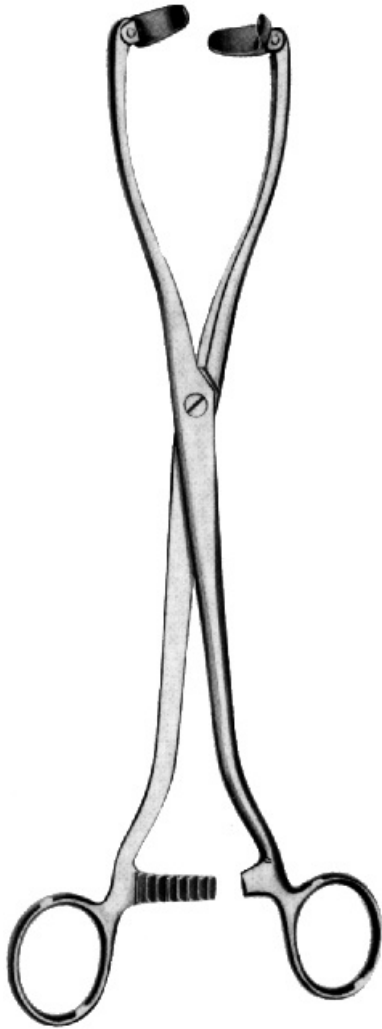

Collin

HB 5000
25,0 cm/10"

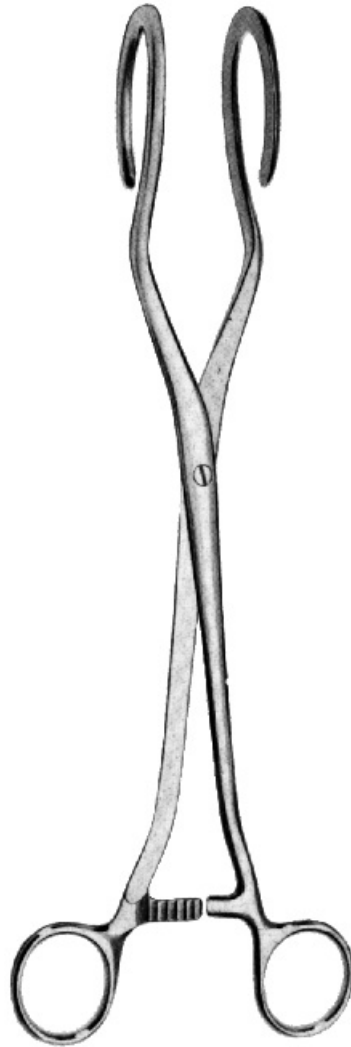

Dartigues

HB 5001
27,0 cm/10½"



Sommer

HB 5002
23,0 cm/9"

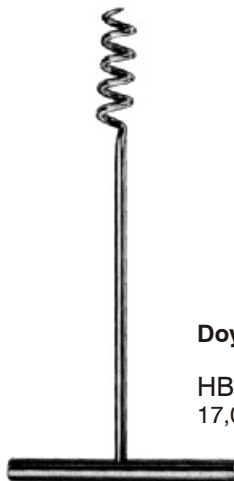

Doyen

HB 5010-01
17,0 cm/6¾"

Myomheber
Myoma Screw
Tracteur de fibrome
Tiramiomas

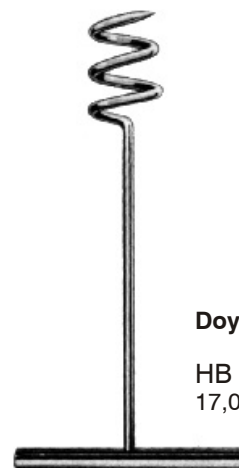

Doyen

HB 5010-02
17,0 cm/6¾"

Faßzangen
Grasping Forceps
Pinces pour saisir
Pinzas para coger

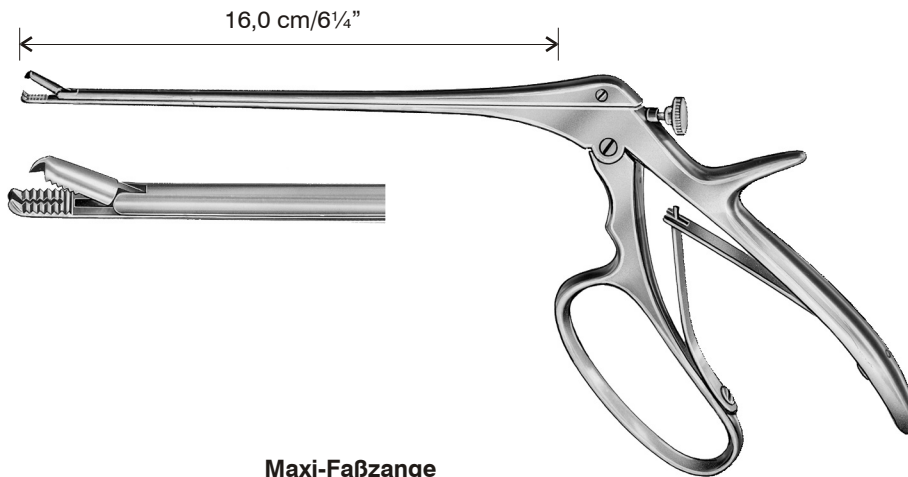

Maxi-Faßzange
Maxi Grasper
Maxi pince pour saisir
Maxi pinza para coger

HB 5015

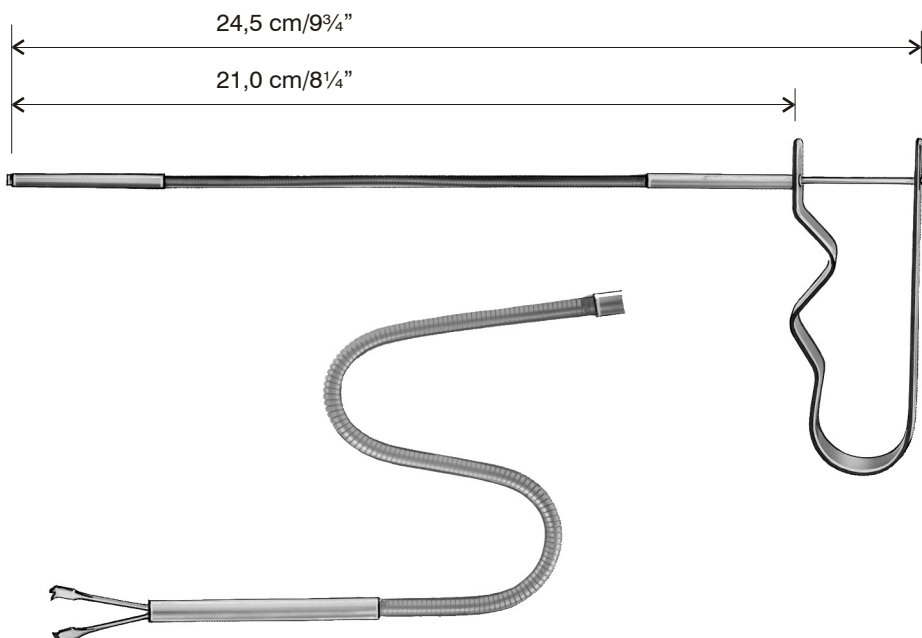

Flexible IUD Faßzange
Serpentine Grasper flexible IUD
Pince flexible IUD
Pinza flexible D.I.U

HB 5018

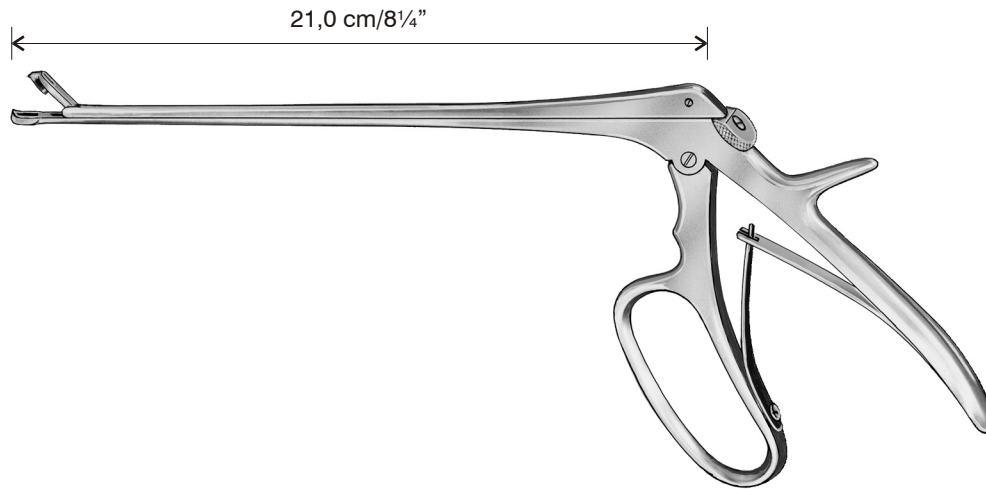

3 x 9 mm

Tischler-Kevorkian

HB 5020



3 x 7 mm

Tischler

HB 5021



2,3 x 4 mm

Baby-Tischler

HB 5022



2,3 x 4 mm

Mini-Tischler

HB 5023



3 x 9 mm

Kevorkian

HB 5024



3 x 7 mm

Coppelson

HB 5025

Biopsiezangen
Biopsy Punches
Pinces emporte-pièces à biopsie
Pinzas para biopsia

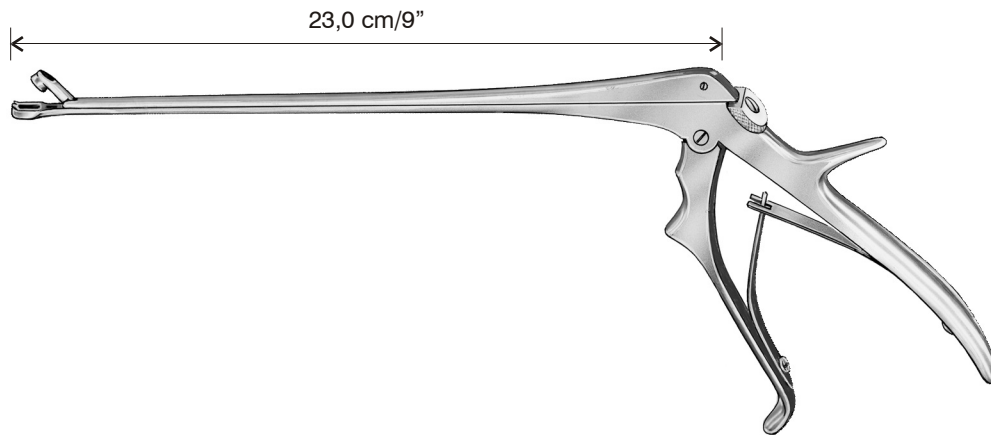

○ 3 x 5 mm

Burke

HB 5026



○ 4 x 6,5 mm

Baggish

HB 5027
gezahnt
toothed
dentelée
dentada

Biopsiezangen
Biopsy Punches
Pinces emporte-pièces à biopsie
Pinzas para biopsia

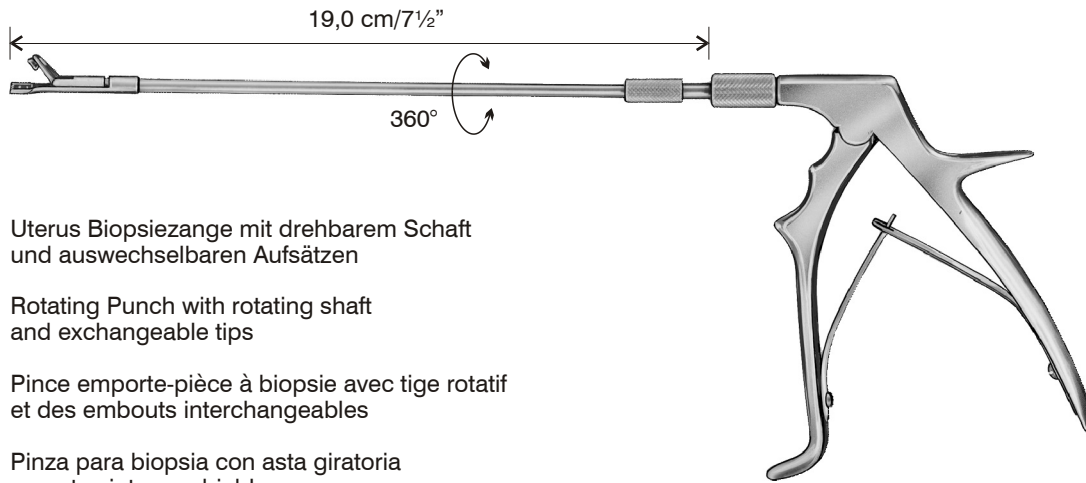

Uterus Biopsiezange mit drehbarem Schaft und auswechselbaren Aufsätzen

Rotating Punch with rotating shaft and exchangeable tips

Pince emporte-pièce à biopsie avec tige rotatif et des embouts interchangeables

Pinza para biopsia con asta giratoria y puntas intercambiables



○ 3 x 7 mm

Uni-Tischler gerade
straight
droite
recta
HB 5028-01
komplett, complete
complet, completo



○ 3 x 7 mm

Uni-Tischler abwärts gebogen
downwards curved
courbe vers le bas
curva hacia abajo
HB 5028-02
komplett, complete
complet, completo



○ 3 x 7 mm

Uni-Tischler aufwärts gebogen
upwards curved
courbe vers le haut
curva hacia arriba
HB 5028-03
komplett, complete
complet, completo



□ 2,3 x 4 mm

Uni-Townsend gerade
straight
droite
recta
HB 5029-01
komplett, complete
complet, completo



□ 2,3 x 4 mm

Uni-Townsend abwärts gebogen
downwards curved
courbe vers le bas
curva hacia abajo
HB 5029-02
komplett, complete
complet, completo



□ 2,3 x 4 mm

Uni-Townsend aufwärts gebogen
upwards curved
courbe vers le haut
curva hacia arriba
HB 5029-03
komplett, complete
complet, completo



○ 3 x 5 mm

Uni-Oval
HB 5030
komplett, complete
complet, completo



□ 3 x 9 mm

Uni-Kevorkian
HB 5031
komplett, complete
complet, completo



○ 3 x 4 mm

Uni-Burke
HB 5032
komplett, complete
complet, completo



△ 3,8 x 6 mm

Schuhmacher
HB5032-38
komplett, complete

Biopsiezangen
Biopsy Punches
Pinces emporte-pièces à biopsie
Pinzas para biopsia



Uni-Griff mit Ring
 Handle with ring
 Manche avec anneau
 Mango con anillo
 HB 5033

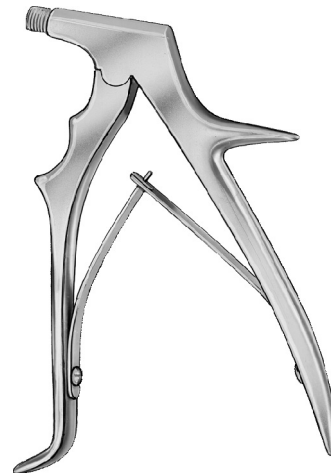

Uni-Griff
 Handle
 Manche
 Mango
 HB 5034



○ 3 x 7 mm

Uni-Tischler gerade
 straight
 HB 5035-01 droite
 recta
 Aufsatz allein mit Rohr
 Tip only with tube
 Embout seul avec tubes-rallonge
 Punta sola con tubo de extensión



○ 3 x 7 mm

Uni-Tischler abwärts gebogen
 downwards curved
 HB 5035-02 courbe vers le bas
 curva hacia abajo
 Aufsatz allein mit Rohr
 Tip only with tube
 Embout seul avec tubes-rallonge
 Punta sola con tubo de extensión



○ 3 x 7 mm

Uni-Tischler aufwärts gebogen
 upwards curved
 HB 5035-03 courbe vers le haut
 curva hacia arriba
 Aufsatz allein mit Rohr
 Tip only with tube
 Embout seul avec tubes-rallonge
 Punta sola con tubo de extensión



□ 2,3 x 4 mm

Uni-Townsend gerade
 straight
 HB 5036-01 droite
 recta
 Aufsatz allein mit Rohr
 Tip only with tube
 Embout seul avec tubes-rallonge
 Punta sola con tubo de extensión



□ 2,3 x 4 mm

Uni-Townsend abwärts gebogen
 downwards curved
 HB 5036-02 courbe vers le bas
 curva hacia abajo
 Aufsatz allein mit Rohr
 Tip only with tube
 Embout seul avec tubes-rallonge
 Punta sola con tubo de extensión



□ 2,3 x 4 mm

Uni-Townsend aufwärts gebogen
 upwards curved
 HB 5036-03 courbe vers le haut
 curva hacia arriba
 Aufsatz allein mit Rohr
 Tip only with tube
 Embout seul avec tubes-rallonge
 Punta sola con tubo de extensión



○ 3 x 5 mm

Uni-Oval
 HB 5037
 Aufsatz allein mit Rohr
 Tip only with tube
 Embout seul avec tubes-rallonge
 Punta sola con tubo de extensión



□ 3 x 9 mm

Uni-Kevorkian
 HB 5038
 Aufsatz allein mit Rohr
 Tip only with tube
 Embout seul avec tubes-rallonge
 Punta sola con tubo de extensión



○ 3 x 4 mm

Uni-Burke
 HB 5039
 Aufsatz allein mit Rohr
 Tip only with tube
 Embout seul avec tubes-rallonge
 Punta sola con tubo de extensión



◁ 3,8 x 6 mm

Schuhmacher
 Aufsatz allein mit Rohr
 Tip only with tube
 Embout seul avec tubes-rallonge
 Punta sola con tubo de extensión
 HB 5039-38

Biopsiezangen
Biopsy Punches
Pinces emporte-pièces à biopsie
Pinzas para biopsia

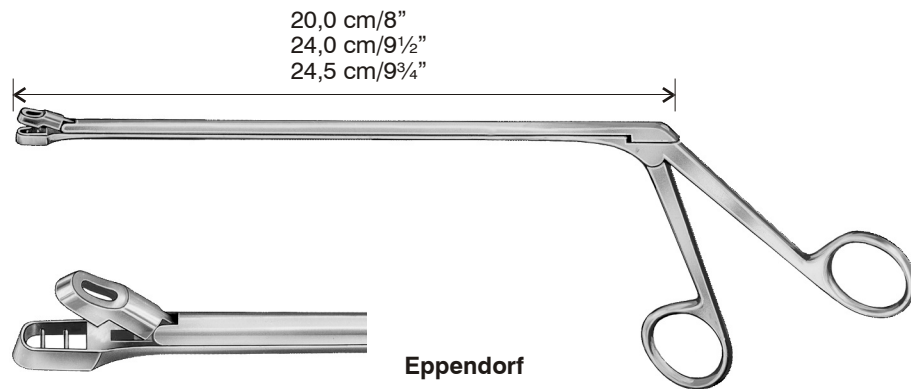

 4,5 x 8 mm

Eppendorf

HB 5040
20,0 cm/8"



 4,5 x 8 mm

Wittner

HB 5041
20,0 cm/8"
gebogen, curved
courbe, curva

Wittner

HB 5042
20,0 cm/8"
gerade, straight
droite, recta



 4 mm = Fig. 1

 6 mm = Fig. 2

Schumacher

Fig. 1
HB 5043
24,0 cm/9 1/2"

Schumacher

Fig. 2
HB 5044
24,0 cm/9 1/2"



 3 x 9 mm

Kevorkian

HB 5049
24,5 cm/9 1/2"

Biopsiezangen
Biopsy Punches
Pinces emporte-pièces à biopsie
Pinzas para biopsia



25,0 cm/10"



Schuhmacher

HB 5047
 komplett, complete
 complet, completo



4 mm

Schuhmacher

HB 5048
 Aufsatz allein
 Tip only
 Embout seul
 Punta sola

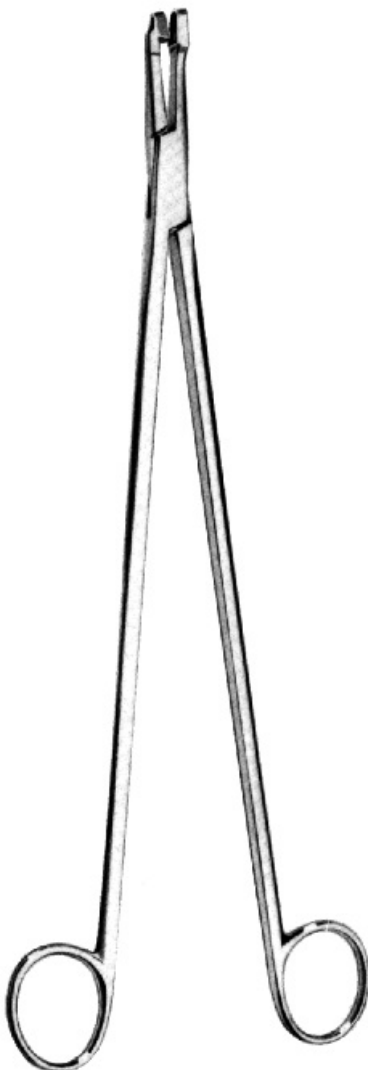

Schubert

HB 5051 21,0 cm/8¼"
 HB 5052 29,0 cm/11½"

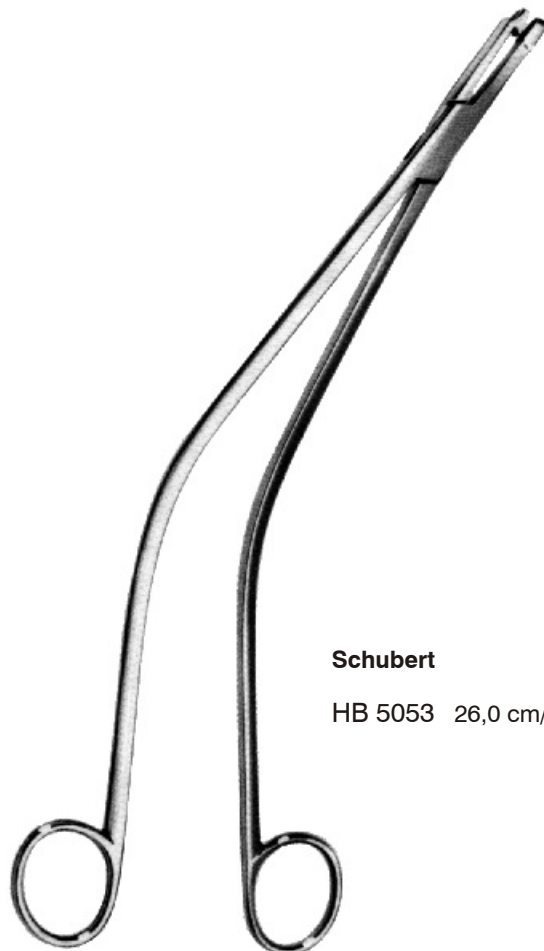

Schubert

HB 5053 26,0 cm/10¼"

Biopsiezangen
Biopsy Punches
Pinces emporte-pièces à biopsie
Pinzas para biopsia



Tischler

HB 5054
27,0 cm/10½"

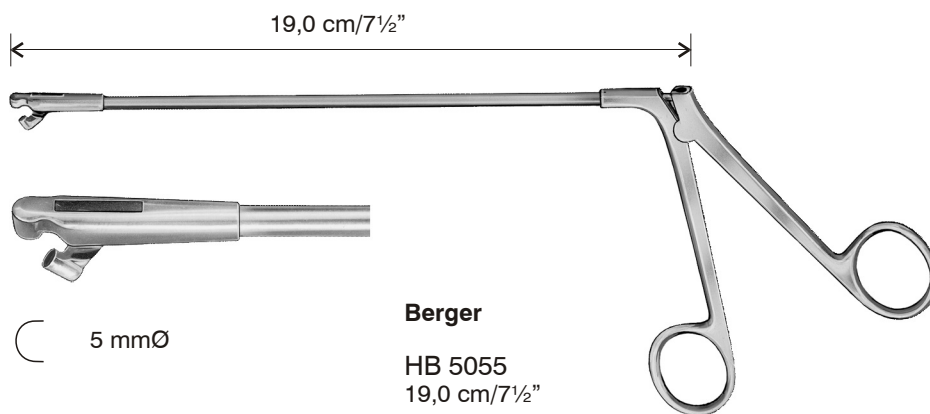

Berger

HB 5055
19,0 cm/7½"

Biopsiezangen
Biopsy Punches
Pinces emporte-pièces à biopsie
Pinzas para biopsia

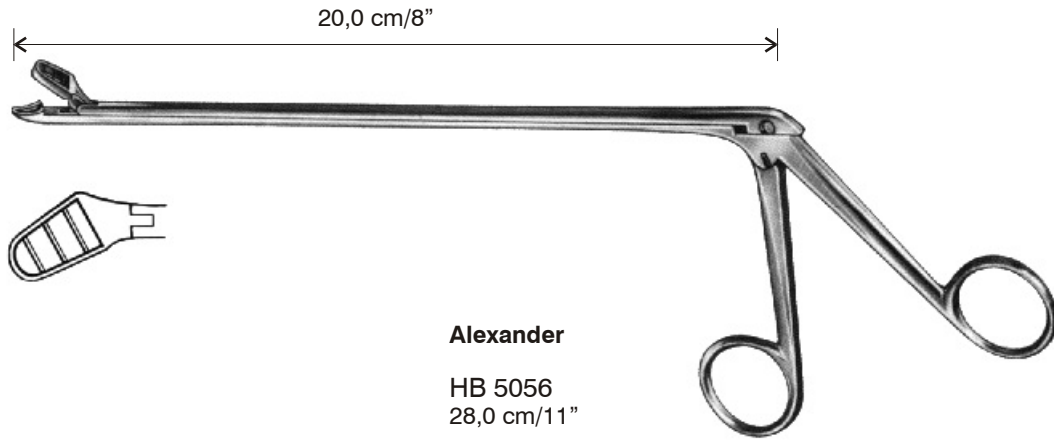

Alexander
 HB 5056
 28,0 cm/11"

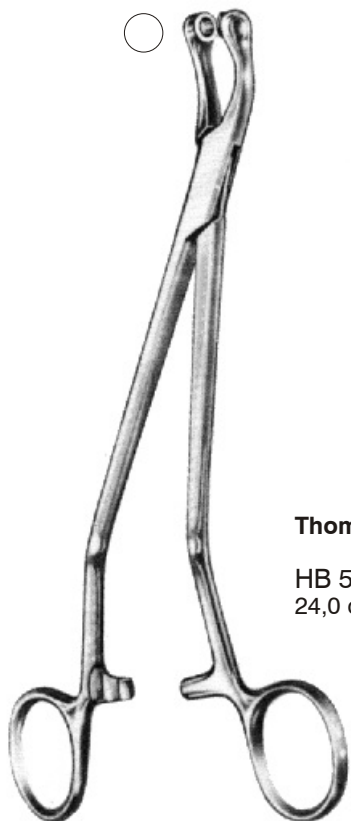

Thoms-Gaylor
 HB 5057
 24,0 cm/9½"

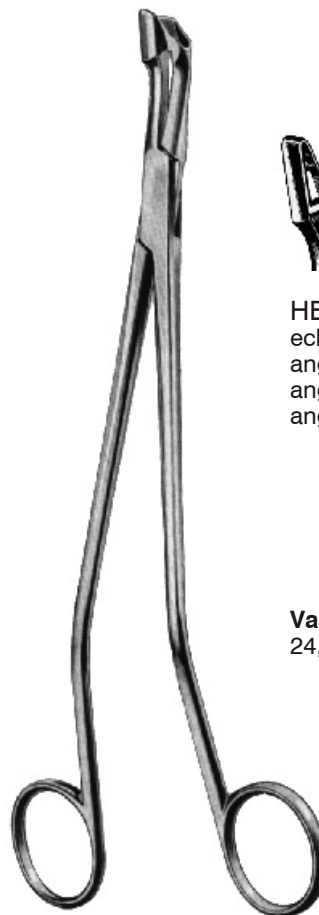

HB 5058
 eckig
 angular
 angulaire
 angular



HB 5059
 rund
 round
 ronde
 redonda

Van Doren
 24,0 cm/9½"

Biopsieküretten
Biopsy Curettes
Curettes pour biopsie
Curetas para biopsia



Novak
23 cm/9"

- Fig. 1 1 mm = HB 5060-01
- Fig. 2 2 mm = HB 5060-02
- Fig. 3 3 mm = HB 5060-03
- Fig. 4 4 mm = HB 5060-04



Randall

HB 5061
24 cm/9½"

Ø 4 mm



Ø 4,5 mm

Rotokürette
Rotating curette
Curette à rotation
Cureta rotatoria

arbeitet drehend
works rotating
fonctionne avec rotation
trabaja rotatoria

Rotokürette

HB 5062
30 cm/11¾"



1 mm

Kevorkian

HB 5063
30 cm/11¾"

schmal
narrow
étroite
estrecha

Biopsieküretten
Biopsy Curettes
Curettes pour biopsie
Curetas para biopsia



Kevorkian

HB 5064
 2,5 mm
 ohne Korb, eckig
 without basket, angular
 sans panier, angulaire
 sin cesta, angular

Kevorkian

HB 5065
 2,2 mm
 mit Korb, rund
 with basket, round
 avec panier, ronde
 con cesta, redonda

Kevorkian-Young

HB 5066
 2,5 mm
 mit Korb, eckig
 with basket, angular
 avec panier, angulaire
 con cesta, angular

Kevorkian
 30,0 cm/11¾"

Novak-Schoeckaert

HB 5067
 24,0 cm/9½"



Mod. Muenchen

HB 5068
 27,0 cm/10½"

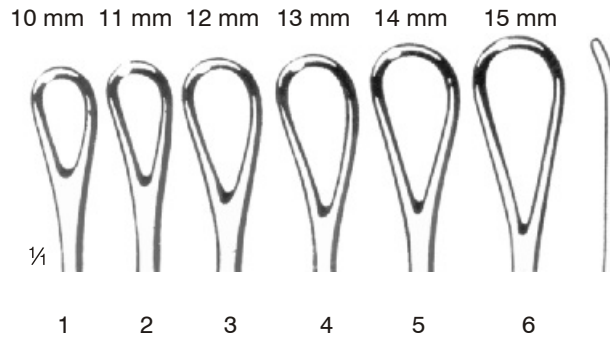

Thomas
 28,0 cm/11"

stumpf, biegsam, glatt
 blunt, malleable, smooth
 mousse, malléable, lisse
 roma, maleable, lisa

- Fig. 1 HB 5071
- Fig. 2 HB 5072
- Fig. 3 HB 5073
- Fig. 4 HB 5074
- Fig. 5 HB 5075
- Fig. 6 HB 5076

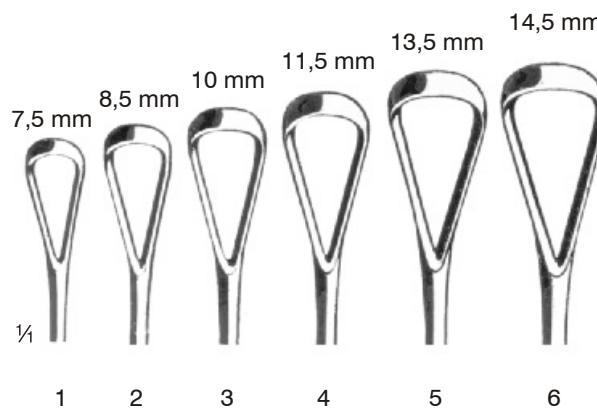

Sims
 25,0 cm/10"

scharf, biegsam sharp, malleable tranchante, malléable cortante, maleable	scharf, fest sharp, rigid tranchante, rigide cortante, rigida	stumpf, biegsam blunt, malleable mousse, malléable roma, maleable	stumpf, fest blunt, rigid mousse, rigide roma, rigida
--	--	--	--

Fig. 1	HB 5081	HB 5091	HB 5101	HB 5111
Fig. 2	HB 5082	HB 5092	HB 5102	HB 5112
Fig. 3	HB 5083	HB 5093	HB 5103	HB 5113
Fig. 4	HB 5084	HB 5094	HB 5104	HB 5114
Fig. 5	HB 5085	HB 5095	HB 5105	HB 5115
Fig. 6	HB 5086	HB 5096	HB 5106	HB 5116

Uterusküretten
Uterine Curettes
Curettes utérines
Curetas uterinas



Recamier
 31,0 cm/12¼"

	mm	scharf, biegsam sharp, malleable tranchante, malléable cortante, maleable	scharf, fest sharp, rigid tranchante, rigide cortante, rigida	stumpf, biegsam blunt, malleable mousse, malléable roma, maleable	stumpf, fest blunt, rigid mousse, rigide roma, rigida
Fig. 00	5	HB 5120-20	HB 5130-20	HB 5140-20	HB 5150-20
Fig. 0	6	HB 5120-00	HB 5130-00	HB 5140-00	HB 5150-00
Fig. 1	7	HB 5120-01	HB 5130-01	HB 5140-01	HB 5150-01
Fig. 2	8	HB 5120-02	HB 5130-02	HB 5140-02	HB 5150-02
Fig. 3	9	HB 5120-03	HB 5130-03	HB 5140-03	HB 5150-03
Fig. 4	11	HB 5120-04	HB 5130-04	HB 5140-04	HB 5150-04
Fig. 5	12	HB 5120-05	HB 5130-05	HB 5140-05	HB 5150-05
Fig. 6	14	HB 5120-06	HB 5130-06	HB 5140-06	HB 5150-06
Fig. 7	15	HB 5120-07	HB 5130-07	HB 5140-07	HB 5150-07
Fig. 8	16	HB 5120-08	HB 5130-08	HB 5140-08	HB 5150-08
Fig. 9	19	HB 5120-09	HB 5130-09	HB 5140-09	HB 5150-09
Fig. 10	20	HB 5120-10	HB 5130-10	HB 5140-10	HB 5150-10
Fig. 11	21	HB 5120-11	HB 5130-11	HB 5140-11	HB 5150-11
Fig. 12	23	HB 5120-12	HB 5130-12	HB 5140-12	HB 5150-12
Fig. 13	25	HB 5120-13	HB 5130-13	HB 5140-13	HB 5150-13
Fig. 14	30	HB 5120-14	HB 5130-14	HB 5140-14	HB 5150-14
Fig. 15	35	HB 5120-15	HB 5130-15	HB 5140-15	HB 5150-15
Fig. 16	40	HB 5120-16	HB 5130-16	HB 5140-16	HB 5150-16

Uterusküretten
Uterine Curettes
Curettes utérines
Curetas uterinas

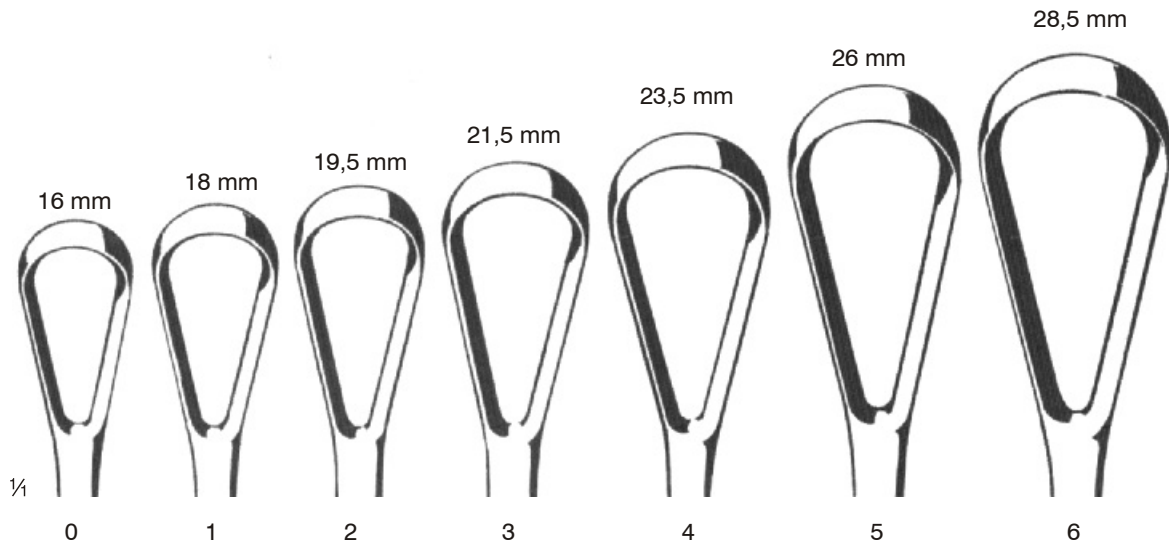

Bumm
 28,0 cm/11"

scharf, biegsam sharp, malleable tranchante, malléable cortante, maleable	stumpf, biegsam blunt, malleable mousse, malléable roma, maleable
--	--

Fig. 0	HB 5160	HB 5170
Fig. 1	HB 5161	HB 5171
Fig. 2	HB 5162	HB 5172
Fig. 3	HB 5163	HB 5173
Fig. 4	HB 5164	HB 5174
Fig. 5	HB 5165	HB 5175
Fig. 6	HB 5166	HB 5176

Uterusküretten
Uterine Curettes
Curettes utérines
Curetas uterinas

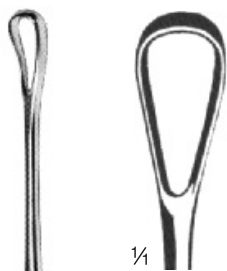

doppelt, scharf-stumpf
 double, sharp-blunt
 double, tranchante-mousse
 doble, cortante-roma



Blake

HB 5180
 27,0 cm/10½"

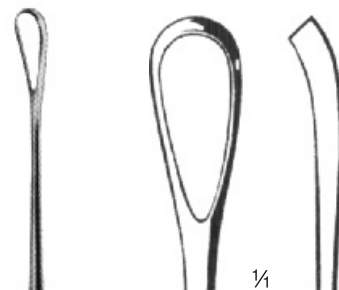

doppelt, scharf-stumpf
 double, sharp-blunt
 double, tranchante-mousse
 doble, cortante-roma



Zweifel

HB 5181
 31,0 cm/12¼"

Uteruslöffel
Uterine Curettes
Curettes utérines
Curetas uterinas



Fig. 1
HB 5190-01



Fig. 2
HB 5190-02



Fig. 3
HB 5190-03



Fig. 4
HB 5190-04



Fig. 5
HB 5190-05



Fig. 6
HB 5190-06



1/2

Simon
25,0 cm/10"

scharf, fest
sharp, rigid
tranchante, rigide
cortante, rigida



Fig. 1
HB 5191-01



Fig. 2
HB 5191-02



Fig. 3
HB 5191-03



Fig. 4
HB 5191-04



Fig. 5
HB 5191-05



Fig. 6
HB 5191-06



1/2

Schroeder
30,0 cm/12"

scharf, fest
sharp, rigid
tranchante, rigide
cortante, rigida

Beckenzirkel
Pelvimeters
Pelvimètres
Pelvimetros

Geburtszangen
Obstetrical Forceps
Forceps obstétriques
Forceps obstétricos

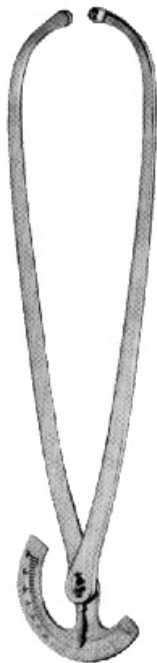

Collin

HB 5301
35,0 cm/13³/₄"



Martin

HB 5302
34,0 cm/13¹/₂"



Naegele

HB 5310 36,0 cm/14"
HB 5311 40,0 cm/16"



Simpson-Braun

HB 5318 30,0 cm/12"
HB 5320 33,0 cm/13"
HB 5321 36,0 cm/14"



Simpson-Luikart

HB 5323 36,0 cm/14"

Geburtszangen
Obstetrical Forceps
Forceps obstétriques
Forceps obstétricos



Kielland

HB 5325 41,0 cm/16"



Kielland-Luikart

HB 5327 40,0 cm/15¾"



Piper

HB 5330 44,0 cm/17¼"



Elliot

HB 5333 38,0 cm/15"

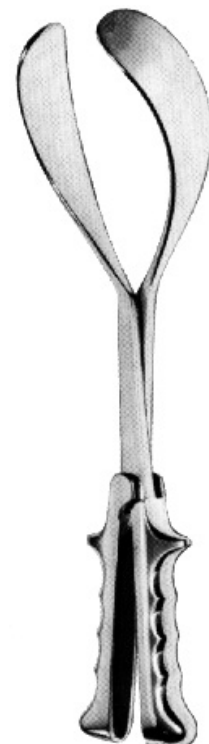

Mc Lean-Tucker

HB 5338 39,0 cm/15½"

Plazenta- und Abortuszangen
Placenta and Ovum Forceps
Pinces placentaires
Pinzas para aborto y placenta

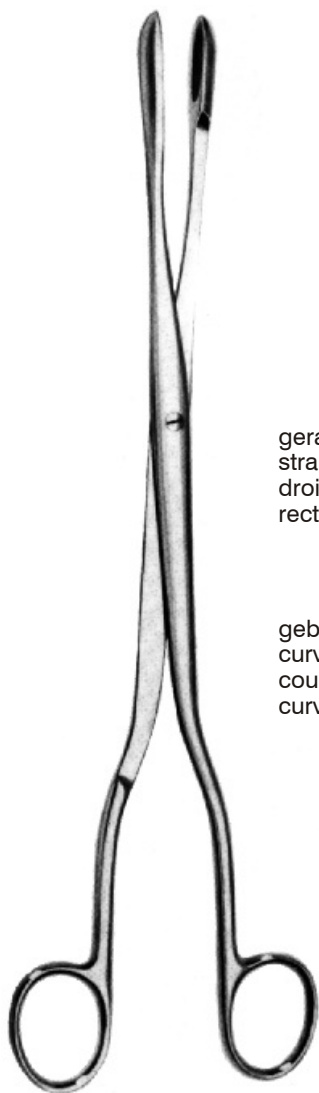

Winter
 28,0 cm/11"

gerade
 straight
 droite
 recta

gebogen
 curved
 courbe
 curva



HB 5380



HB 5381



HB 5382

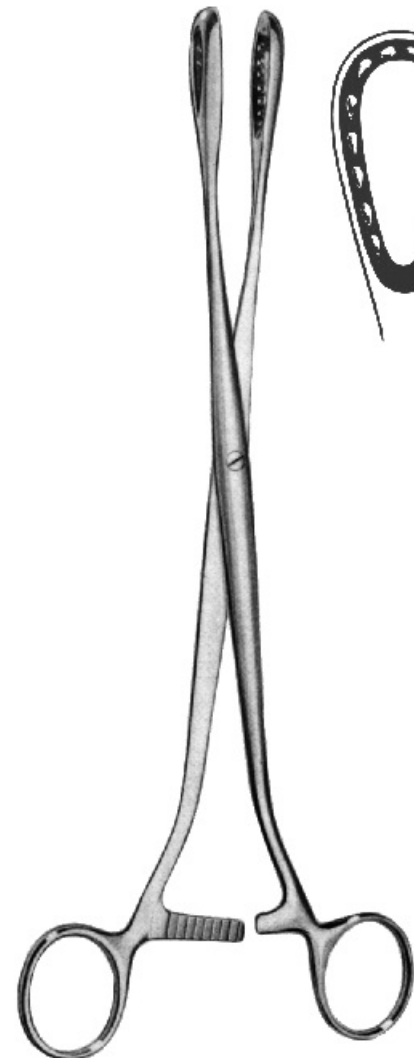

Saenger
 27,0 cm/10½"

HB 5390

HB 5391

gerade
 straight
 droite
 recta

gebogen
 curved
 courbe
 curva



Uterusklemmzange
Uterine Hemostasis Forceps
Pince-clamp utérine
Pinza-clamp uterina

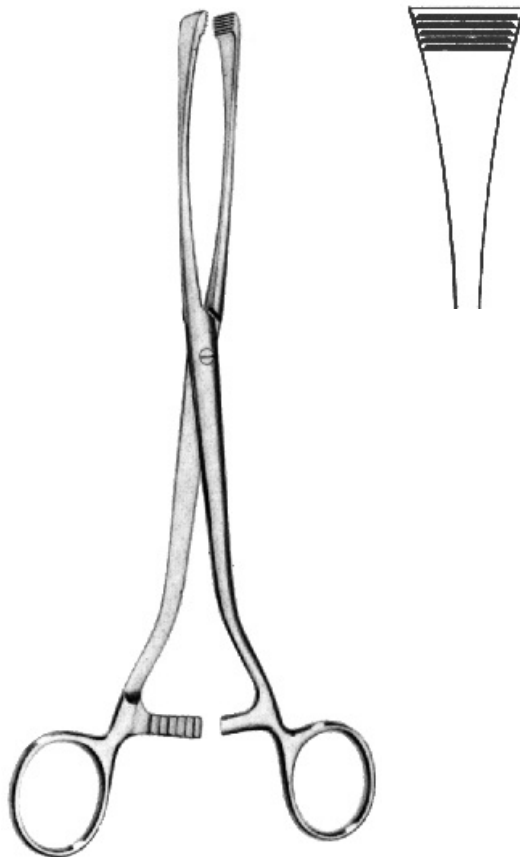

Green-Armytage

HB 5395
21,0 cm/8¼"

