

HAEBERLE

multifunctional medical
cart systems ...and more

ISO module and functional trolleys for the clinic

keo[®]

price list

valid up from 1 July 2008



- the flexible and creative functional trolley generation for medical applications

HAEBERLE's trolley system **keo[®]** opens new dimensions for form and functionality conscious people. With their mobility, flexibility and attractive design the ergonomic functional trolleys really provide practical solutions. A new order concept provides uncluttered work surfaces. With the **keo[®]** system you are able to create almost any types of functional trolleys in a standardised design for your clinic. With its drawers, module full-pull-outs or elegant roller blinds of various heights, **keo[®]** optimally adapts to your furnishing ideas and your modern ambience. Flexible module support walls enable accommodating ISO module baskets of all conventional makes – even at a later date.

keo[®] as supply trolleys, anaesthetic trolleys, ward trolleys, module trolleys, dressing trolleys, emergency trolleys ...

the technology:

- A rugged, torsionally stiff sheet metal construction of galvanized, high-quality, coated sheet metal. Resistant to disinfectants, easy to clean and light-resistant. Free of drumming due to single-tray construction. Very low weight!
- 4 elegant, anodised aluminium support profiles for mounting accessories. Subsequent mounting of accessories is also possible.
- An elegant, anodised aluminium push handle is standard.
- All module full-pull-outs are provided with an inset frame suitable for all conventional ISO module baskets. The pull-out is extendable up to approx. 110%, so that the module contents are comfortably and easily removable.
- Drawers are equipped also with full-pull-outs (110%).
- Inset frames and drawers with ball bearing telescopic guidance with self pull-in for easy gliding and comfortable use.
- High-quality, Ø 125 mm, smoothly-running castors with 2 brakes and with wall guards are standard. Electrically conductive castors are available at an additional price.
- Total load of the trolleys up to approx. 130 kg.

the colours:

Trolley colours: grey white RAL 9002, night-blue RAL 5022, white aluminium RAL 9006. Drawer modules and module full-pull-out handles and decorative strips are available in: grey, blue, red violet, yellow and turquoise. We are pleased to offer other colours on a project basis.

the dimensions:

Case width: (incl. castors and wall guards) 770 mm
 Case depth: (incl. castors and wall guards)..... 580 mm
 Case height, (incl. castors)..... 918/1.041/1.169 mm
 Overall width (incl. 1 push handle and wall guards).... 810 mm

Item	Description	Ref. no.	Price €
------	-------------	----------	---------

In your order please specify the colour code by adding it as the last digit to the reference number.
The following colour combinations are possible:

- xxxx1** = trolley grey white RAL 9002, handles and decorative strips grey
- xxxx2** = trolley grey white RAL 9002, handles and decorative strips blue
- xxxx3** = trolley grey white RAL 9002, handles and decorative strips red violet
- xxxx4** = trolley grey white RAL 9002, handles and decorative strips yellow
- xxxx5** = trolley grey white RAL 9002, handles and decorative strips turquoise
- xxxx6** = trolley night-blue RAL 5022, handles white aluminium RAL 9006, decorative strips night-blue RAL 5022
- xxxx7** = trolley white aluminium RAL 9006, handles and decorative strips grey

Other RAL colour combinations on request.

Function trolleys for ISO modules

Recommended combinations, which can be supplemented or altered whenever necessary. **All functional trolleys are delivered fully assembled at no additional cost.** The price includes the elegant push handle.

keo® ISO module trolleys

The keo® ISO module trolleys are suitable for all conventional ISO module systems. You can choose between the more comfortable module full-pull-out frames, which can be extended to 110%, or module support walls. We have compiled a selection of functional trolleys for you. Using the various system and accessory components you can at any time put together your very own special model customized to your requirements. **The modules are not included in the presented module trolleys. You can use your own module stocks or purchase modules from us.**

ISO- module trolley with drawer

NEW

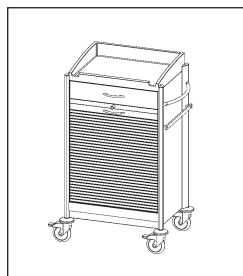

ABS-plastic work surface with a four-sided raised edge, aluminium colour roller blind with lock, inkl. 2 ISO module support walls for 5 ISO modules (100 - 110 mm), 1 drawer 125, 1 standard profile rail (stainless steel).

4 castors Ø 125 mm with 2 brakes and wall guards, 1 push handle.

Dim.: 810 x 580 x 1.244 mm (w x d x h) **1895** □ 1.398,- A

ISO module trolley I

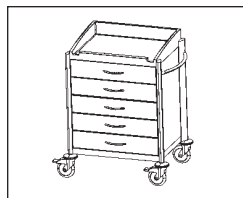

ABS-plastic work surface with a four-sided raised edge, 5 ISO module full-pull-outs (110%) for supporting 50 or 100 mm high ISO modules,

four 125 mm Ø castors with 2 brakes and wall guards, 1 push handle.

Dim.: 810 x 580 x 990 mm (w x d x h) **1851** □ 1.426,- A

ISO module trolley II

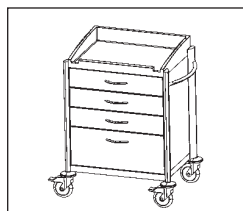

ABS-plastic work surface with a four-sided raised edge, 3 ISO module full-pull-outs (110%) for supporting 50 or 100 mm high ISO modules, 1 module full-pull-out for supporting 200 mm high ISO modules,

four 125 mm Ø castors with 2 brakes and wall guards, 1 push handle.

Dim.: 810 x 580 x 990 mm (w x d x h) **1852** □ 1.327,- A

ISO module trolley III

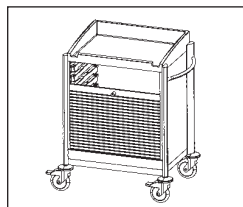

ABS-plastic work surface with a four-sided raised edge, aluminium colour roller blind with lock, behind two support walls for ISO modules,

four 125 mm Ø castors with 2 brakes and wall guards, 1 push handle.

Dim.: 810 x 580 x 990 mm (w x d x h) **1853** □ 1.263,- A

ISO module trolley IV

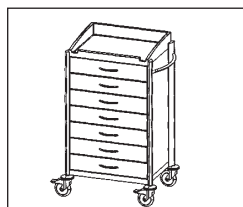

ABS-plastic work surface with a four-sided raised edge, 7 ISO module full-pull-outs (110%) for supporting 50 or 100 mm high ISO modules,

four 125 mm Ø castors with 2 brakes and wall guards, 1 push handle.

Dim.: 810 x 580 x 1.242 mm (w x d x h) **1854** □ 1.722,- A

Item	Description	Ref. no.	Price €
------	-------------	----------	---------

ISO module trolley V

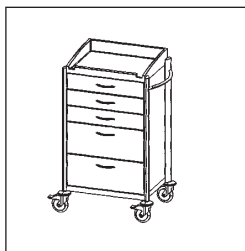

ABS-plastic work surface with a four-sided raised edge, 3 ISO module full-pull-outs (110%) for supporting 50 or 100 mm high ISO modules, 2 module full-pull-outs for supporting 200 mm high ISO modules,

four 125 mm Ø castors with 2 brakes and wall guards, 1 push handle.

Dim.: 810 x 580 x 1.242 mm (w x d x h) **1855** □ 1.498,- A

ISO module trolley VI

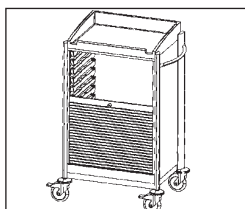

ABS-plastic work surface with a four-sided raised edge, aluminium colour roller blind with lock, two support walls for ISO modules,

four 125 mm Ø castors with 2 brakes and wall guards, 1 push handle.

Dim.: 810 x 580 x 1.242 mm (w x d x h) **1856** □ 1.398,- A

keo®- ISO-Anaesthetic trolleys with module full-pull-outs

ISO-Anaesthetic trolley I

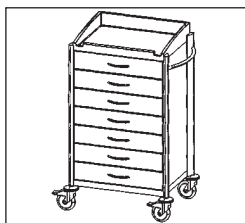

ABS-plastic work surface with a four-sided raised edge with insertion stainless steel plate, 7 module full-pull-outs (110%) for supporting 50 or 100 mm high modules,

four 125 mm Ø castors with 2 brakes and wall guards, 1 push handle.

Dim.: 810 x 580 x 1.242 mm (w x d x h) **1861** □ 1.753,- A

ISO-Anaesthetic trolley II

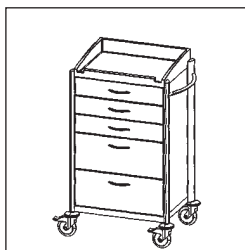

ABS-plastic work surface with a four-sided raised edge with insertion stainless steel plate, 3 module full-pull-outs (110%) for supporting 50 or 100 mm high modules. 2 module full-pull-outs (110%) for supporting 200 mm high ISO-modules.

Four 125 mm Ø castors with 2 brakes and wall guards, 1 push handle.

Dim.: 810 x 580 x 1.242 mm (w x d x h) **1862** □ 1.594,- A

ISO-Anaesthetic trolley III

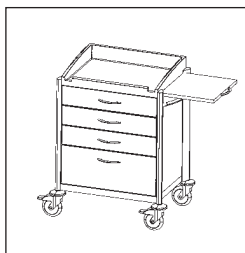

ABS-plastic work surface with a four-sided raised edge with insertion stainless steel plate and side extension (metal), 3 module full-pull-outs (110%) for supporting 50 or 100 mm high ISO modules, 1 module full-pull-out (110%) for supporting a 200 mm high ISO module,

four 125 mm Ø castors with 2 brakes and wall guards, 1 push handle.

Dim.: 810 x 580 x 990 mm (w x d x h) **1863** □ 1.642,- A

keo® Dressing and treatment trolleys

Treat yourself to clear work spaces. The new organisation system allows you to compactly store all common material packages and leaves the work surface free for your preparations. Two capacious, tilted deposit levels provided with adjustable clips provide room for all types of packages. Ergonomical placement, variable equipping. Work is a pleasure using the intelligently shaped and easy to clean work surface with its rounded corners.

Dressing and treatment trolley with side extension

NEW



PicBox® injection set with 3 large and 5 small boxes, ABS-plastic work surface with a four-sided raised edge and with side extension.

4 ISO module full-pull-out 125, 1 ISO module full-pull-out 250, 1 design waste bin,

4 castors Ø 125 mm with 2 brakes and wall guards, 1 push handle.

Dim.: 810 x 580 x 1.600 mm (w x d x h) **1896** □ 2.176,- A

Item	Description	Ref. no.	Price €
------	-------------	----------	---------

Dressing and treatment trolley III

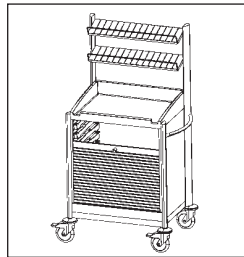

an organisation system with 2 deposit levels plus clips, an ABS-plastic work surface with a four-sided raised edge, aluminium colour roller blind with lock, two support walls for ISO modules,

four 125 mm Ø castors with 2 brakes and wall guards, 1 push handle.

Dim.: 810 x 580 x 1453 mm (w x d x h) **1864** □ 1.545,- A

Dressing and treatment trolley IV

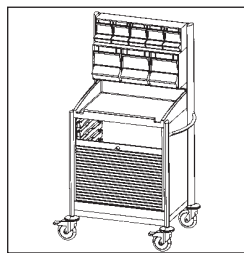

PicBox® injection set, with 3 large and 5 small boxes, ABS-plastic work surface with a four-sided raised edge, aluminium colour roller blind with lock, two support walls for ISO modules,

four 125 mm Ø castors with 2 brakes and wall guards, 1 push handle.

Dim.: 810 x 580 x 1453 mm (w x d x h) **1865** □ 1.694,- A

Dressing and treatment trolley V

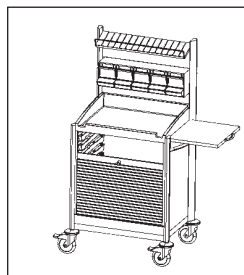

an organisation system with 1 deposit level plus clips, a PicBox® cannula dispenser, with 5 small pockets, an ABS-plastic work surface with a four-sided raised edge and side extension, aluminium colour roller blind with lock, two support walls for ISO modules,

four 125 mm Ø castors with 2 brakes and wall guards, 1 push handle.

Dim.: 810 x 580 x 1453 mm (w x d x h) **1866** □ 1.749,- A

keo® Emergency trolley

Modules are not included in the basic models of the emergency trolley presented here. You can use your own module stocks or purchase modules from us.

Emergency trolley I

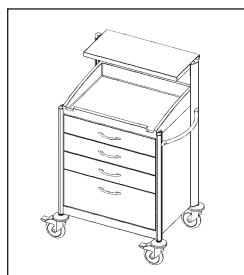

300 mm deep platform with anti-slide mat for defibrillators and other devices, ABS-plastic work surface with a four-sided raised edge, 3 ISO module full-pull-outs (110%) for supporting 50 or 100 mm high ISO modules. 1 module full-pull-out (110%) for supporting a 200 mm high ISO module,

four electrically conductive Ø 125 mm castors with 2 brakes and wall guards, 1 push handle.

Dim.: 810 x 607 x 1.180 mm (w x d x h) **1857** □ 1.593,- A

Emergency trolley II

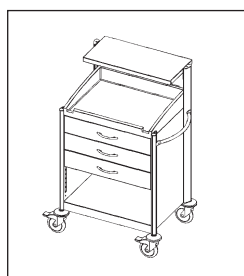

300 mm deep platform with anti-slide mat for defibrillators and other devices, ABS-plastic work surface with a four-sided raised edge, 3 ISO module full-pull-outs (110%) for supporting 50 or 100 mm high ISO modules, 1 open compartment, 250 mm high with anti-slide mat,

four electrically conductive Ø 125 mm castors with 2 brakes and wall guards, 1 push handle.

Dim.: 810 x 607 x 1.180 mm (w x d x h) **1858** □ 1.498,- A

Item	Description	Ref. no.	Price €
------	-------------	----------	---------

keo® function trolleys with metal drawer

If you prefer fixed drawers over ISO modules, we recommend the following models. All drawers have a very comfortable 110% pull-out feature. You can also mix module drawers and standard drawers and configure system and accessory units to suit your individual purposes. We will be glad to assist you.

Treatment trolley with filing cabinet

NEW

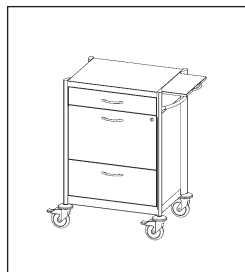

Work surface, powder-coated metal (grey-white RAL 9002) with a side extension, powder-coated metal (white aluminium RAL 9006), 1 drawer 125, 1 drawer 250, 1 filing cabinet DIN A4 with lock

4 castors Ø 125 mm with 2 brakes and wall guards, 1 push handle.

Dim.: 810 x 580 x 1.038 mm (w x d x h) **1897** □ 1.775,- A

Dressing and treatment trolley I

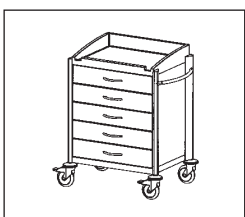

ABS-plastic work surface with a four-sided raised edge, 5 drawers, 125 mm high, with full-pull-outs (110%), inside dim.: 570 x 395 x 92 mm (w x d x h), four 125 mm Ø castors with 2 brakes and wall guards, 1 push handle.

Dim.: 810 x 580 x 990 mm (w x d x h) **1832** □ 1.685,- A

Dressing and treatment trolley II

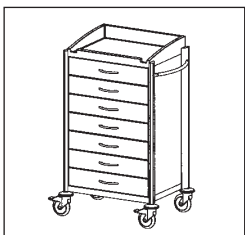

ABS-plastic work surface with a four-sided raised edge, 7 drawers, each 125 mm high, with full-pull-outs (110%), inside dim.: 570 x 395 x 92 mm (w x d x h),

four 125 mm Ø castors with 2 brakes and wall guards, 1 push handle.

Dim.: 810 x 580 x 1.242 mm (w x d x h) **1838** □ 2.058,- A

Anaesthetic trolley I

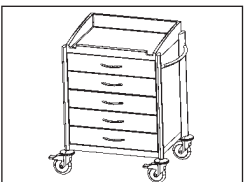

ABS-plastic work surface with a four-sided raised edge with insertion stainless steel plate, 5 drawers with full-pull-outs (110%), each 125 mm high,

four 125 Ø mm castors with 2 brakes and wall guards, 1 push handle.

Inside dim.: 570 x 395 x 92 (w x d x h),

Dim.: 810 x 580 x 990 mm (w x d x h) **1859** □ 1.711,- A

Anaesthetic trolley II

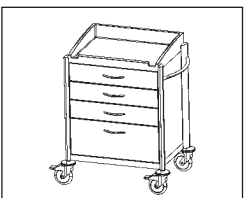

ABS-plastic work surface with a four-sided raised edge with insertion stainless steel plate, 3 drawers, each 125 mm high, with full-pull-outs (110%), inside dim.: 570 x 395 x 92 (w x d x h), 1 drawer, 250 mm high, with full-pull-out (110%), inside dim.: 570 x 395 x 220 (w x d x h),

four 125 mm Ø castors with 2 brakes and wall guards, 1 push handle.

Dim.: 810 x 580 x 990 mm (w x d x h) **1860** □ 1.583,- A

keo® System parts - as customized as your requirements

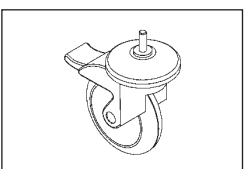

Castors

Castors

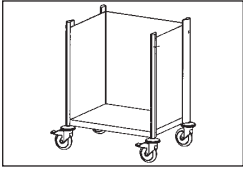
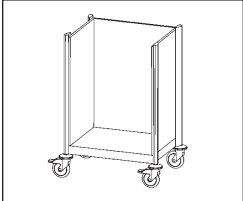
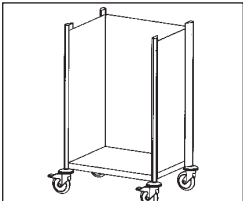
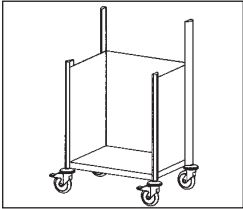
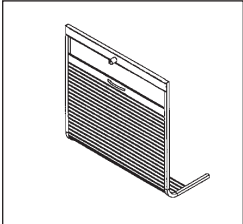

additional cost of four 125 mm Ø smoothly-running and electrically conductive castors, 2 castors with brakes.

18064 88,- A

Item	Description	Ref. no.	Price €
Case			
Case for 5 height grids		with 125 mm Ø smoothly-running castors with wall guards and 2 brakes.	Dim.: 810 x 580 x 913 mm (w x d x h)
1818		597,-	A
Case for 6 height grids		with 125 mm Ø smoothly-running castors with wall guards and 2 brakes.	Dim.: 810 x 580 x 1.041 mm (w x d x h)
1879		620,-	A
Case for 7 height grids		with 125 mm Ø smoothly-running castors with wall guards and 2 brakes.	Dim.: 810 x 580 x 1.169 mm (w x d x h)
1819		656,-	A
Case for 5 height grids, with extended profile supports, at rear		to support the organisation system or PicBox® sets, or similar articles, with 125 mm Ø smoothly-running castors with wall guards and 2 brakes.	Dim.: 810 x 580 x 1.451 mm (w x d x h)
1841		625,-	A
Roller blind / module support walls			
Roller blind incl. 2 ISO module support walls		Roller blind made of high-quality plastic, aluminium colour with lock and handle, easy to clean. ISO module support walls made of grey plastic (ABS) to insert ISO modules 600 x 400 mm (w x d).	
NEW		The ref.no. include the roller blind with ISO module support walls (right and left side)	
18844	for 4 ISO modules, 100 - 110 mm high	suitable for case for 5 height grids (ref.no. 18181.-.7 or 1841.1.-.7)	448,-
18845	for 5 ISO modules, 100 - 110 mm high	suitable for case for 6 height grids (ref.no. 1879.1.-.7)	448,-
18846	for 7 ISO modules, 100 - 110 mm high	suitable for case for 7 height grids (ref.no. 1819.1.-.7)	448,-
		The installation of a drawer or an ISO module full-pull-out 125 reduced the number of deployable ISO modules.	
		If you use different heights of ISO modules you can put in more or less ISO modules.	
		Please contact our team of consultants.	

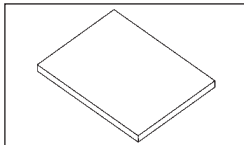
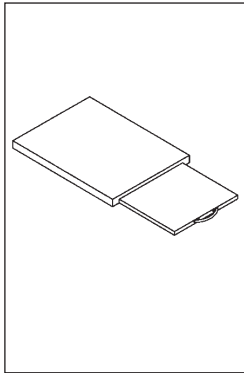
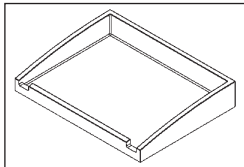
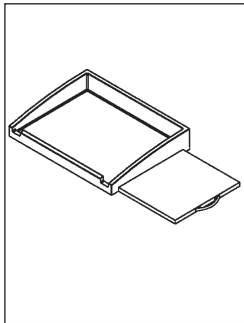
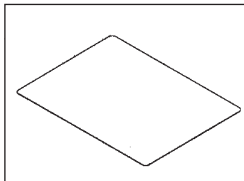
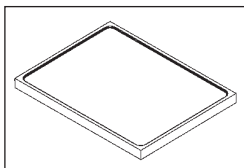
Item	Description	Ref. no.	Price €
Work surfaces / panel board / shelves / shelf for writing or laptop			
Work surface 485 mm deep		powder-coated metal, grey-white RAL 9002	18091 83,- A
		night-blue RAL 5022 white aluminium RAL 9006	18093 83,- A 18092 83,- A
Work surface 485 mm deep with a side extension		work surface powder-coated metal, Dim.: 634 x 485 x 40 mm (w x d x h),	
		pull-out plate, metal white aluminium powder-coated, RAL 9006, extendable on right-hand side drawing distance: 340 mm, Dim.: 376 x 432 x 15,5 mm (w x d x h),	
		work surface: grey-white RAL 9002, handle colour	
		grey	18071 244,- A
		blue	18072 244,- A
		violet red	18073 244,- A
		yellow	18074 244,- A
turquoise	18075 244,- A		
night-blue RAL 5022, handle colour: whitealuminium	18076 244,- A		
white aluminium RAL 9006, handle colour: grey	18077 244,- A		
If a central locking or anti-tamper seal is mounted, the extension is only possible to the left side.			
Work surface with a raised edge on 4 sides		grey ABS-plastic. Dim.: 634 x 484 x 110 mm (w x d x h)	18097 167,- A
Work surface with a raised edge on 4 sides with side extension		work surface grey ABS-plastic, Dim.: 634 x 484 x 110 mm (w x d x h),	
		pull-out plate, metal white aluminium powder-coated, RAL 9006, extendable on right-hand side, drawing distance: 340 mm Dim.: 376 x 432 x 15,5 mm (w x d x h),	
		handle colour of the pull-out plate:	
		grey	18461 275,- A
		blue	18462 275,- A
		violet red	18463 275,- A
		yellow	18464 275,- A
turquoise	18465 275,- A		
white aluminium	18466 275,- A		
If a central locking or anti-tamper seal is mounted, the extension is only possible to the left side.			
Panel board for work surface with a raised edge on all 4 sides		stainless steel Dim.: 588,5 x 440,5 x 1 mm (w x d x h)	18128 49,- A
Stainless steel work surface with a beaded edge		rugged due to the pattern-rolled surface structure. Dim.: 634 x 484 x 40 mm (w x d x h)	18095 283,- A

Item	Description	Ref. no.	Price €
------	-------------	----------	---------

Stainless steel work surface with a beaded edge and side extension

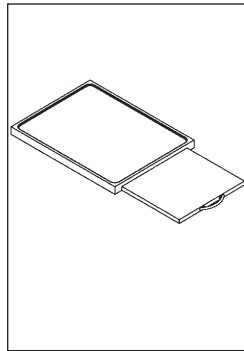

with pattern-rolled surface structure,
Dim.: 634 x 484 x 40 mm (w x d x h),

pull-out plate, metal white aluminium powder-coated, RAL 9006, extendable on right-hand side, drawing distance: 340 mm,
Dim.: 376 x 432 x 15,5 mm (w x d x h),

handle colour of the pull-out plate:

grey	18451	525,-	A
blue	18452	525,-	A
violet red	18453	525,-	A
yellow	18454	525,-	A
turquoise	18455	525,-	A
white aluminium	18456	525,-	A

If a central locking or anti-tamper seal is mounted, the extension is only possible to the left side.

Shelf

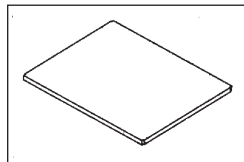

to cover drawers or module full-pull-outs.

Dim.: 628 x 482 x 20 mm (w x d x h)

grey-white	18467	99,-	A
night-blue	18468	99,-	A
white aluminium	18469	99,-	A

Shelf 300 mm deep

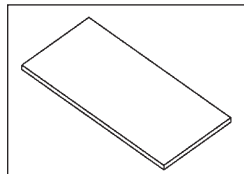

powder-coated metal,

Dim.: 634 x 300 x 20 mm (w x d x h)

grey-white RAL 9002	18061	79,-	A
night-blue RAL 5022	18063	79,-	A
white aluminium RAL 9006	18062	79,-	A

Shelf for writing or laptop

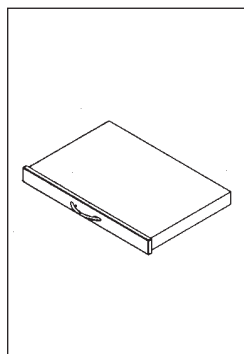

extensible to the front, mounted on full-pull-out (110%).
Dim.: 602 x 400 x 61 mm (w x d x h),

shelf: grey-white, RAL 9002, handle colour:

grey	18500	206,-	A
blue	18503	206,-	A
violet red	18504	206,-	A
yellow	18505	206,-	A
turquoise	18506	206,-	A

night-blue RAL 5022

handle colour white aluminium **18501** 206,- A

white aluminium RAL 9006

handle colour grey **18502** 206,- A

Drawers / module full-pull-outs / module for notebook / filing cabinet

Drawer 125

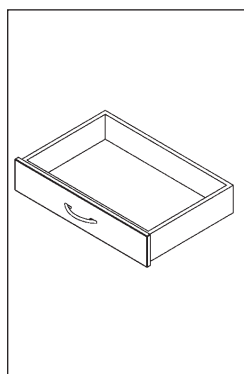

with full-pull-out (110%), height 125 mm
Inside dim.: 570 x 395 x 92 mm (w x d x h),

drawer: grey-white, RAL 9002, handle colour:

grey	18121	211,-	A
blue	18122	211,-	A
violet red	18123	211,-	A
yellow	18124	211,-	A
turquoise	18125	211,-	A

night-blue RAL 5022

handle colour white aluminium **18126** 211,- A



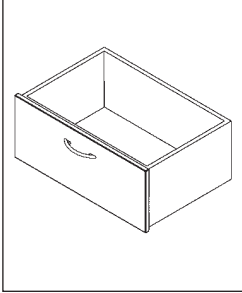
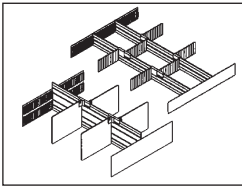
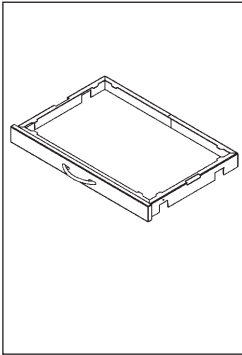
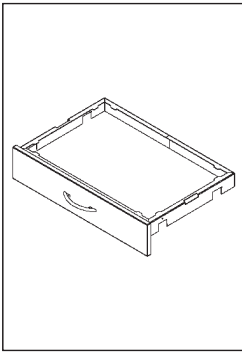
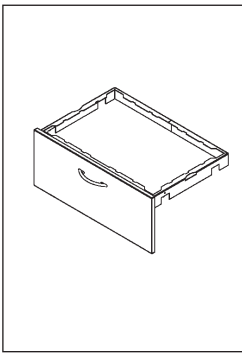

white aluminium RAL 9006

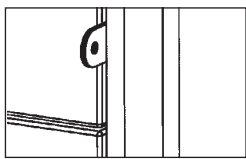
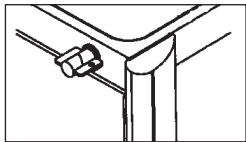
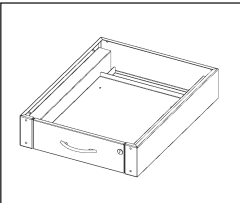
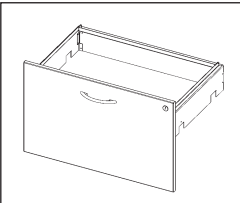
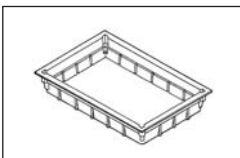

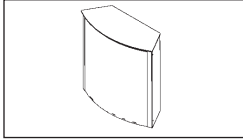
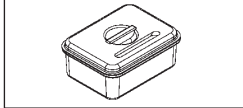
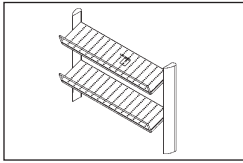
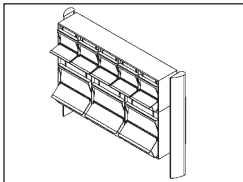
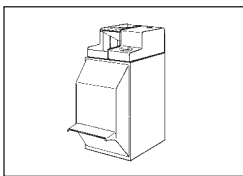
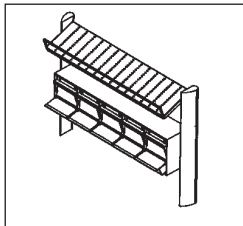
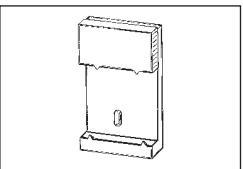
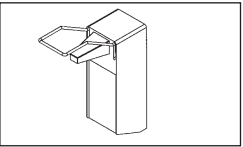
handle colour grey **18127** 211,- A

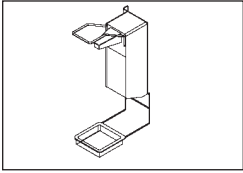
Item	Description	Ref. no.	Price €	
Drawer 250	 <p>with full-pull-out (110%), height 250 mm Inside dim.: 570 x 395 x 220 mm (w x d x h), drawer: grey-white RAL 9002, handle colour</p>	18131	243,- A	
		grey	18132	243,- A
		blue	18133	243,- A
		violet red	18134	243,- A
		yellow	18135	243,- A
		turquoise	18136	243,- A
		night-blue RAL 5022 handle colour white aluminium white aluminium RAL 9006 handle colour grey	18137	243,- A
Drawer inset	 <p>with flexible compartments</p>	for drawer 125 mm	18430 42,- A	
		for drawer 250 mm	18431 112,- A	
Module full-pull-out 61	 <p>to support 50 mm high ISO modules, extendable by 110% to enable easy removal of the ISO module, 61 mm height Dim.: 634 x 418 x 61 mm (w x d x h) module full-pull-out: grey-white RAL 9002, handle colour:</p>	grey	18441 156,- A	
		blue	18442 156,- A	
		violet red	18443 156,- A	
		yellow	18444 156,- A	
		turquoise	18445 156,- A	
		night-blue RAL 5022 handle colour white aluminium white aluminium RAL 9006 handle colour grey	18446 156,- A	
			18447 156,- A	
Module full-pull-out 125	 <p>to support 50 or 100 mm high ISO modules, extendable by 110% to enable easy removal of the ISO module, 125 mm height Dim.: 634 x 418 x 125 mm (w x d x h) module full-pull-out: grey-white RAL 9002, handle colour:</p>	grey	18141 159,- A	
		blue	18142 159,- A	
		violet red	18143 159,- A	
		yellow	18144 159,- A	
		turquoise	18145 159,- A	
		night-blue RAL 5022 handle colour white aluminium white aluminium RAL 9006 handle colour grey	18146 159,- A	
			18147 159,- A	
Module full-pull-out 250	 <p>to support 200 mm high ISO modules, extendable by 110% to enable easy removal of the ISO module, 250 mm height Dim.: 634 x 418 x 250 (w x d x h) module full-pull-out: grey-white RAL 9002, handle colour:</p>	grey	18151 179,- A	
		blue	18152 179,- A	
		violet red	18153 179,- A	
		yellow	18154 179,- A	
		turquoise	18155 179,- A	
		night-blue RAL 5022 handle colour white aluminium white aluminium RAL 9006 handle colour grey	18156 179,- A	
			18157 179,- A	

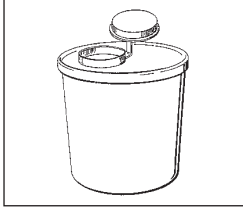
Item	Description	Ref. no.	Price €
Pull-out stop	for drawers and module full-pull-outs. When one e.g. drawer is opened, all others are locked	18437	79,- A
Central locking	for 2-5 drawers or module full-pull-outs for 6-7 drawers or module full-pull-outs	18440 18438	238,- A 242,- A
Anti-tamper seal	for 1 pull-out, without one-way seals	17797	83,- A
			
	for several pull-outs, without one-way seals incl. pull-out stop	18432	223,- A
			
Single use seals	blue plastic	13998	19,70 C
Module for notebook with lock	sideways-extendable and mountable on the left or right side		
NEW			
	Dim.: 485 x 634 x 128 mm (w x d x h) module for notebook: grey-white RAL 9002, handle colour:		
	grey	18921	398,- A
	blue	18922	398,- A
	violet red	18923	398,- A
	yellow	18924	398,- A
	turquoise	18925	398,- A
	night-blue RAL 5022 handle colour white aluminium	18926	398,- A
	white aluminium RAL 9006 handle colour grey	18927	398,- A
Filing cabinet DIN A 4 with lock	forward-extendable		
NEW			
	Dim.: 622 x 416 x 381 mm (w x d x h) Filing cabinet: grey-white RAL 9002, handle colour:		
	grey	18931	389,- A
	blue	18932	389,- A
	violet red	18933	389,- A
	yellow	18934	389,- A
	turquoise	18935	389,- A
	night-blue RAL 5022 handle colour white aluminium	18936	389,- A
	white aluminium RAL 9006 handle colour grey	18937	389,- A
keo® Accessories			
The reference numbers of the accessories specify the accessory and include the assembly material, if applicable. The price includes assembly. However, it is also possible to retrofit accessories to the trolleys.			
ISO module		ABS plastic, light grey RAL 7035, with a pull-out stop	
		Dim.: 600 x 400 x 50 mm (w x d x h)	18421 56,- A
		Dim.: 600 x 400 x 100 mm (w x d x h)	18422 63,- A
ISO wire basket		Rilanised white, with a pull-out stop	
		Dim.: 600 x 400 x 180 mm (w x d x h)	18423 41,- A
		Further wire baskets and other modules on request.	
Divisions for ISO modules		transparent acrylic	
		for transverse divisions 400 x 50 mm (l x h)	18424 9,50 A
		400 x 100 mm (l x h)	18425 10,- A
		for longitudinal divisions 600 x 50 mm (l x h)	18426 11,50 A
		600 x 100 mm (l x h)	18427 12,- A

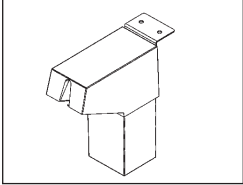
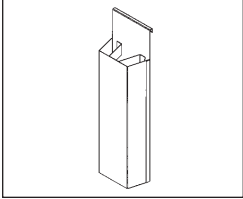
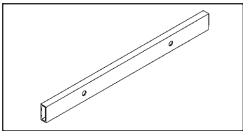
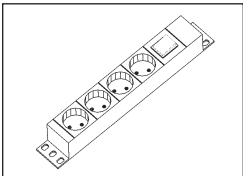
Item	Description	Ref. no.	Price €	
Push handle		anodised aluminium, white aluminium RAL 9006, length approx. 470 mm	17942 46,- A	
Design waste bin		to be mounted on the side, incl. 1 roll of waste bags 15 l, material: mounting is white aluminium powder-coated metal RAL 9006; the lid and front are natural semi-transparent polypropylene.	17809 182,- A	
Waste container for Instruments		with polypropylene bowl with slid lid, can be sterilized, white, with fixed mounting.	17771 129,- A	
Organisation system		with 2 special steel tilted deposit levels and 10 moveable clips for conventional material packages.	17836 262,- A	
PicBox® Injection set	<div style="border: 1px solid black; padding: 2px; display: inline-block;">with back cover</div>		grey-white plastic housing with transparent pockets. Each pocket has its own dust protection cover. Consisting of 3 injection dispensing pockets and 5 cannula dispensing pockets. Mounted by screwing between the profiles.	18006 362,- A
KOMBI set		recommended to complement the PicBox®: for taking blood samples and giving injections. The TAKEFIX swab dispenser and the TIPPFIX swab moisturiser as well as the additional container are of grey-white, unbreakable plastic.	18029 126,- A	
Organisation system with PicBox®		consisting of the PicBox® cannula dispenser with 5 small boxes and 1 special steel deposit level and 5 clips.	17991 318,- A	
Snap universal holder		for dispenser boxes of disposable gloves, tissues or cloths. The spring tension slide holds all types of boxes up to 1 kg in place for single-hand operation.	15572 9,- A	
Soap and disinfectant dispenser		naturally anodised aluminium. Capacity: 1 litre.	17850 134,- A	

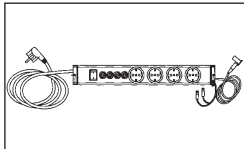
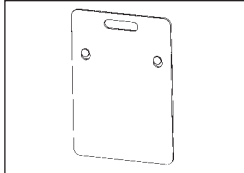
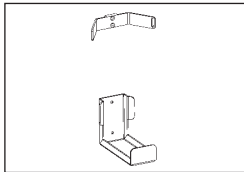
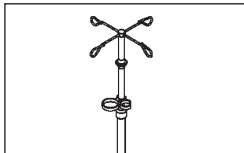
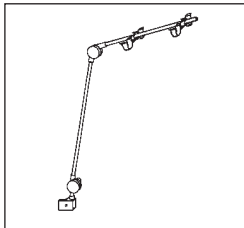
Item	Description	Ref. no.	Price €
Drip pan	 hang up for soap and disinfectant dispenser, ref.no 17850, with removable bowl	16256	60,- A
Schluckfix cannula container	 black, recycled plastic, disposable container for holding approx. 500 used needles. Dim.: 55 x 100 x 170 mm (w x d x h)	18004	106,- A
Schluckfix Original carton	with 100 boxes, without mounting	09490	349,- A
Mounting	for Schluckfix to keo®, separately	18005	28,- A
Medi-Müll disposal box, 1,5 ltrs. capacity	 sun-yellow polypropylene with a HAEBERLE-green lid. It has 3 practical stripping aids for all types of cannula, also a vacutainer. Ideal for scalpels, pipettes, broken glass, swabs, etc., 152 mm high, lid Ø 143 mm, bottom Ø 108 mm, 1,5 ltrs. capacity.	18050	74,- A
Medi-Müll carton	 the amount of packages has changed with 100 boxes, without mounting	16653	129,- A
Mounting	for Medi-Müll to keo®, separately	18059	38,- A
CUPFIX ampoule opener	 grey-white plastic housing, ampoule collector, detachable, diamond file spring-loaded in a stainless steel plate. Dim.: 70 x 150 x 200 mm (w x d x h)	18058	118,- A
	Spare diamond file for CUPFIX	04663	31,- A
Mounting	for CUPFIX to keo®, separately	18060	28,- A
Catheter container	 stainless steel, subdivided into 3 sections. To be fixed at standard profile rail. . Please order standard profile rail, ref.no. 17943, separately. Dim.: 160 x 80 x 570 mm (w x d x h)	18065	134,- A
Standard profile rail	 stainless steel with 2 securing points. 480 mm long and for lateral fastening. Please specify the side on which the rail is to be secured.	17943	83,- A
Socket board	 4 grounding sockets in accordance with DIN 49440, 16 A - 230 VAC, light-grey cable HO5VVF, 3G 1.5 mm ² , 3 m in length with moulded grounding plug, green 2-pin switch, quality housing anodised aluminium, incl. 2 grey plastic fastening angles. Dim.: 264 x 44,5 x 44,5 mm (w x d x h) The multiple socket board corresponds to EN 60 601-1 and all other relevant DIN, EN and IEC standards.	16327	68,- A

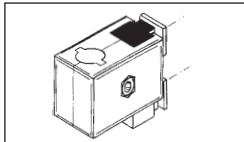
Quality multi-socket with equipotential bonding		for the connection of several medical apparatus. With 4 sockets and 4 POAG plugs. A 5 m long power cord and a 5 m long POAG cord with an elbow jack. The ON/OFF switch is illuminated. Conforms fully to EN 60601.	13935	268,- A	
Cardiac massage board		for the emergency trolley, the Trespa solid-core material is especially hygienic and fully disinfectable;	Dim.: 440 x 10 x 640 mm (w x d x h)	13948	223,- A
Emergency set for artificial respiration and suctioning on request!					
Mounting for oxygen bottle		for the 5/10 litre oxygen bottle, Ø of 140 mm	Mounting	18168	130,- A
			Top holder with fixing tape, separately	18169	65,- A
Infusion bottle holder		chromium-plated, with four 25 mm Ø hooks, for single-hand operation		18020	223,- A
Cable and hose holder		grey, approx. 950 mm reach, including attachment clamp		18433	140,- A
Cable and hose holder with flex-shaft		with 2 joints of plastic, arms in silver aluminium and chromium-plated flex-shaft. With attachment		18943	319,- A
NEW					
Attachment clamp		or fastening various accessories to keo®, suitable for holding Ø 10 mm and Ø 16 mm circular tubes		18018	40,50 A

All prices are understood exclusive of VAT. As an innovative company we reserve the right to amend prices and designs. As for the rest our General Terms of Business in the valid version apply.

WEEE-Reg.-Nr. DE 20235235



Planning sketch for individual keo® trolleys

Case for 5 height grids

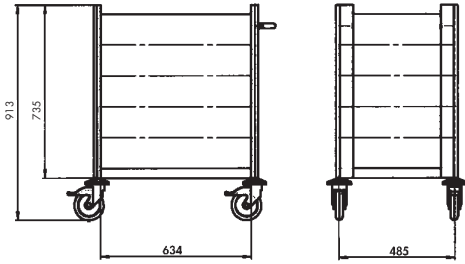

Case for 6 height grids

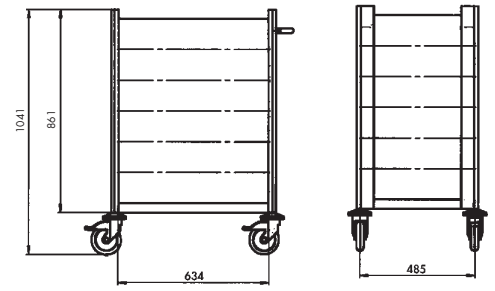

Case for 7 height grids

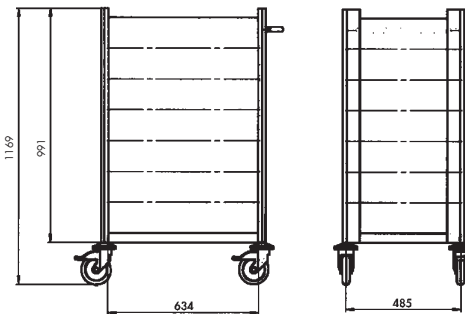

Case for 5 height grids with extended profile supports at rear

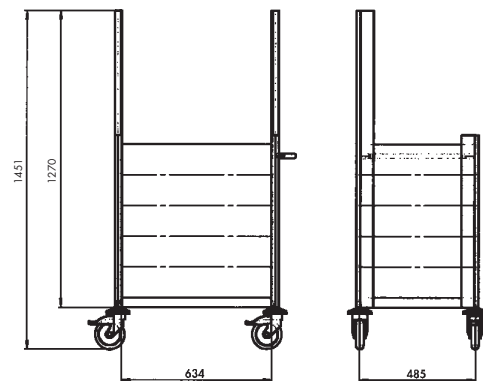

Work surfaces:

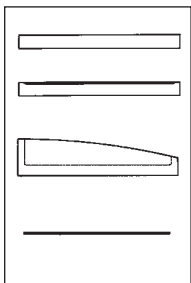

- Metal
- Stainless steel
- Plastic with raised edges
- Insertion stainless steel plate

Accessories:

Ref. no. / Description / Quantity

Ref. no.	Description	Quantity

Colour combinations:

- | Case | Handles/decorative strips |
|-----------------------------------|--|
| <input type="checkbox"/> RAL 9002 | <input type="checkbox"/> grey |
| <input type="checkbox"/> RAL 9002 | <input type="checkbox"/> blue |
| <input type="checkbox"/> RAL 9002 | <input type="checkbox"/> red violet |
| <input type="checkbox"/> RAL 9002 | <input type="checkbox"/> yellow |
| <input type="checkbox"/> RAL 9002 | <input type="checkbox"/> turquoise |
| <input type="checkbox"/> RAL 5022 | <input type="checkbox"/> RAL 9006/5022 |
| <input type="checkbox"/> RAL 9006 | <input type="checkbox"/> grey |

- | | |
|----------|-----------------|
| RAL 9002 | grey-white |
| RAL 9006 | white-aluminium |
| RAL 5022 | night-blue |

Other RAL colour combinations on request!



HAEBERLE specializes in particular in providing customized OEM versions for industrial clients. Let us know your specification and we will provide you a product according to your personally requirements.

Please contact us!

HAEBERLE GmbH + Co. KG
Breitwiesenstraße 13 · D-70565 Stuttgart
P.O.Box 800524 · D-70505 Stuttgart
Phone ++49 (0) 7 11/7 83 14-0
Fax ++49 (0) 7 11/7 83 14-77
e-mail: info@haeberle-med.de
www.haerberle-med.de

Your medical distributor